

V. *The Ginger-Beer Plant, and the Organisms composing it: a Contribution to the Study of Fermentation-Yeasts and Bacteria.*

By H. MARSHALL WARD, *Sc.D., F.R.S., F.L.S., late Fellow of Christ's College, Cambridge, Professor of Botany at the Forestry School, Royal Indian Engineering College, Cooper's Hill.*

Received January 14,—Read January 21, 1892.

[PLATES 11–16.]

INTRODUCTORY.

IN 1887 my attention was directed to a curious substance, or structure, popularly known in many parts of the country as the Ginger-beer Plant, from its association with the domestic manufacture of the well-known summer beverage so often purchased in villages and towns in various parts of the British Isles, where it is usually put up in brown stone bottles, with tied corks. My earliest specimens of the Ginger-beer plant were obtained from Mr. THISTLETON DYER, of Kew, who called my attention to its mysterious nature, and from Professor BAYLEY BALFOUR, of Edinburgh, then Professor of Botany in the University of Oxford, who exhibited specimens at a meeting of the Linnean Society in 1887.* Since then I have obtained specimens from various sources in this country and abroad; and during the progress of a long series of investigations have elicited a number of facts as to the constitution and behaviour of this remarkable agent of fermentation, which, whatever their importance, cannot fail to be of interest to all biologists.

In addition to the gentlemen referred to, who kindly provided me with specimens obtained from Lincolnshire, Oxfordshire, and even from North America, I have also to thank Dr. RANSOME, of Nottingham, and Mr. ADRIAN BROWN, of Burton-on-Trent, for specimens from the towns referred to, and Messrs. LEETE and APPELYARD, for further supplies from Coventry and elsewhere.

It appears that while, on the one hand, the Ginger-beer Plant has long been known in the rural districts of this country, and even abroad, as a mysterious agent which brings about the fermentation of saccharine solutions, to which ginger has been added, and transforms them into an acid effervescing beverage, usually known as home-made ginger-beer, great or even total ignorance prevails, on the other hand, as to the

* See 'Proceedings of the Linnean Society,' July, 1887, pp. 7 and 8.

original source of the "plant," and very little indeed is known as to its real nature. The following studies will at least clear up many of the difficulties on the latter point; but I have met with no success in direct answer to enquiries as to when the Ginger-beer Plant was first discovered, and how it was introduced into this country, or what first led people to employ it in making the beverage which gives it its name.

Professor BAYLEY BALFOUR states:* "it is said the Ginger-beer Plant was introduced into Britain by soldiers from the Crimea, in 1855;" but so far as I can discover this was a mere conjecture, and is not to be taken as an accepted piece of history.

Dr. RANSOME informs me, in a letter dated April, 1891, "some say it was brought from Italy," but this, again, I have failed to substantiate more definitely. The whole question as to whence it was first derived, in fact, is enshrouded in mystery; and it is to be hoped that these studies may so draw attention to the matter that some light will be thrown upon it at a future time. All agree that it is handed on from family to family much in the same way as yeast or "barm" is by brewers and bakers.

As to its nature, the most conflicting views have been put forward. Passing over various mere conjectures to the effect that it consists of forms of *Penicillium*, *Mucor*, or other Mould-Fungi, the sequel will show that the nearest approach to the real state of affairs is BALFOUR's suggestion† that it is composed of a Yeast and a Bacterium. GROVE, in his 'Synopsis of the Bacteria and Yeast Fungi,'‡ regards it as consisting of a Yeast, *Mycoderma*, various species of *Bacillus*, together with PASTEUR's "Mucor-ferment"; but he gives no evidence of having examined the matter in detail, and, as the sequel will show, he entirely misses the main point. Notes on the subject have appeared at various times in the 'Gardener's Chronicle'§ and elsewhere, but they throw no light on the essential nature of the Ginger-beer Plant.

It will be sufficiently evident, therefore, that the mystery was well worth attacking, and that practically nothing was known about it before this investigation was commenced. It may, however, also be noted, that had I known how long and difficult a task I had set myself, the attempt would possibly have been abandoned at an early date.

GENERAL DESCRIPTION.

When seen in the fresh state, as it comes from the ferment flasks or other vessels, the Ginger-beer plant presents the appearance of solid, white, semi-translucent, irregular, lumpy masses, not unlike pieces of soaked sago or tapioca; these lumps are brittle, like firm jelly, and their size varies from that of a pin's head, or smaller, to that of a large plum, or larger—very commonly they are as big as a hazel nut; but, since the pieces often result from the breaking-up of large crusts, or layers,

* *Loc. cit.*, p. 8.

† *Op. cit.*, p. 8.

‡ See note on p. 67.

§ 1884, pp. 542 and 748; 1886, p. 315; 1887, p. 148.

in the residue of the fermentations lining the flasks, &c., and can grow when freely suspended in the liquor of fresh fermentations, it is impossible to say what are the limits of size.

The fresh lumps are brittle, and of a pure white, semi-opaque appearance, as said; but the opacity and brittleness may both vary, even in the same lump. When touched with needles or forceps, the pieces are very apt to slip, and, when a hold is obtained, to break; if squeezed between glass plates, they are found to be very slippery and elastic, reminding one of some forms of cartilage or stiff jelly. Consequently it is not easy to fish out and transfer the floating lumps intact, unless a spoon or similar instrument is employed. When dried, whether in air or over sulphuric acid *in vacuo*, or in absolute alcohol, the volume diminishes considerably, and the shrunken pieces become opaque and lustreless, and often acquire a yellow tinge; they also become more brittle or more horny, according to circumstances.

In other cases, when in the stages of early development in the fermenting vessels, the lumps are softer and more viscous than when fully formed; and, in fact, every transitional stage can be met with from the condition of a slimy, semi-fluid, soft jelly, to that of a hard horny mass which breaks like glue or cartilage.

These physical characteristics are dependent on the amount of water present in the lumps.

Obviously the specific gravity of the fresh pieces will vary according to the amount of water present, also: I have not examined this point in much detail, but the following facts may be noted. The lumps fall rapidly in alcohol, in distilled water, and even in PASTEUR'S solution and other media of high specific gravity. Some idea of the amount of water contained in the lumps may be derived from the following observation:—On August 27th, I started a culture in a sterilised soda-water flask. Five grams of the fresh Ginger-beer plant were put in 500 c.c. of Pasteur-Asparagin;* on September the 11th the carefully collected crop weighed, fresh, after draining on filter paper, just over 52.5 grms. This, dried at 100° C. till it lost no more water, weighed a trifle over 7 grms. Assuming the proportion of water to have been the same in the original 5 grms., its dry weight would have been .66 gm.

Although the fresh dried lumps swell rapidly when placed in water, they do not dissolve in it, even if boiled; in fact, heating them in water renders them whiter and more opaque, much as when they are placed in absolute alcohol, or dried *in vacuo*.

In most cases the fresh moist specimens, received by post from a distance, are distinctly acid, though in varying degrees. In some specimens the acidity was clearly due, in part at least, to acetic acid, owing to the presence of impurities to be explained later on; but in others (perhaps in all) the acidity diminishes or even disappears on boiling in water, and is easily shown to be due to the presence of carbonic acid. The evanescence of the acid reaction to litmus, the effervescence when hot water is poured on the moist lumps, and the precipitation of barium carbonate

* See p. 133.

when they are placed in baryta water, all afford evidence of this; moreover, as will be seen in the sequel, the existence of dissolved carbon dioxide in the moist lumps might be inferred with certainty from their behaviour.

The most striking characteristics of the above-described lumps of Ginger-beer Plant, however, only become evident when they are placed in saccharine solutions, and they are perhaps best shown roughly as follows. A soda-water bottle is filled three parts full of PASTEUR'S fluid, or any other similar solution of sugar in water, and a lump of ginger added. Into this mixture are placed a few lumps of the Ginger-beer Plant; the bottle is then well corked, and laid in a warm place, and observed from time to time. In from 24 to 48 hours, depending on the season, temperature, &c., the liquor is observed to become more and more turbid, and bubbles of gas begin to ascend; the fermentation soon goes on rapidly, and unless the cork is well secured by string or wire, it will be blown out. This primary turbidity is found to be due almost entirely to innumerable yeast-cells, and further examination proves that these yeast-cells are shed from the lumps of Ginger-beer Plant (which rise and fall with varying buoyancy in the liquid), and then multiply in the medium, and soon form a dense greyish deposit at the bottom. The buoyant dancing of the lumps is seen to be determined by the copious evolution of gas-bubbles from their surfaces.

In a few days, if the lumps are vigorous and the conditions favourable, there is serious danger of the bottle bursting, and I have had one or two nasty experiences with such fermentations; consequently, in these rough preliminary experiments, it is best to remove the cork for a few minutes every day. If this is done on, say the third or fourth day, the cork comes out with the well-known pop of a ginger-beer or champagne cork, and the liquid froths over from the copious evolution of gas.

This liquid, on examination, is found to be not only more turbid than before, and surcharged with carbon dioxide, but it is evidently more or less viscous, with a viscosity which is different from any property directly imparted to it by the sugar and other materials added: this viscosity is associated with the copious and persistent frothing. The liquor has of course been changed in other respects also: it is sufficient to say that it is now more or less converted into "ginger-beer."

As time goes on the viscosity increases, and it sometimes happens that the liquid becomes so thick that the gas-bubbles rise comparatively slowly. The viscosity is clearly not due to the mere presence of yeast-cells, because they fall to the bottom: the lumps of Ginger-beer Plant now begin to grow obviously larger, and may continue to do so daily for some time. The microscope shows that the viscosity is due to the presence of innumerable swollen or slimy vermiform bodies distributed through the mass of the liquor. Myriads of rod-shaped bodies (*Bacteria*), are also observable. The increasing deposit below is also found, in the later stages, to consist of *Bacteria*, swarming amongst the yeast-cells. The "ginger-beer" is distinctly acid, as well as viscous: the colour of the liquid is paler than that of the original solution.

As time goes on, the surface of the liquid usually becomes covered with a dense

scum, unless very well corked and protected, the quantity of gas disengaged having fallen to a minimum : then moulds, &c. of various kinds appear, or the "ginger-beer" sets up acetic fermentation : in some cases it even "goes bad, *i.e.*, putrefaction supervenes."

In practice, however, the villagers usually employ a somewhat different mode of procedure for making "ginger-beer." They make a solution of sugar corresponding roughly to a 10-20 per cent. solution in tap-water, in a large open vessel, a little cream of tartar and a few pieces of ginger are then added ; some add lemon as well. The pieces of Ginger-beer plant are then placed in the mixture, and the whole allowed to stand for a day or two. Then the liquor is poured off into bottles and corked, and is drunk after two or three days more. Meanwhile more sugar solution is exposed in the original vessel containing the deposit, or "lees," and allowed to stand and bottled off as before.

In all these cases the chief phenomena are the same. The plant grows, and is alternately buoyed up and falls in the liquid ; it sheds yeast-cells all around, and these increase and form a deposit : the liquid becomes viscous, with slimy masses in it, and more and more acid and surcharged with gas ; *Schizomycetes* and other organisms are found in the deposit, and in the scum at the top. The bottled liquor simply becomes the well-known frothy "ginger-beer" of the country.

It will be obvious that the problems which present themselves to the biologist examining the contents of such vessels as the above, are somewhat as follows. What is the yeast which so rapidly spreads in the earlier stages of fermentation ? What are the slimy vermiform bodies in the liquor ? What species of *Schizomycetes* are present ? What does the scum consist of ? And, finally, what have all, or any, of these organisms to do with the Ginger-beer plant, and the conversion of the saccharine liquor into "Ginger-beer" ? Such are the problems of which the solution is attempted in the following studies.

The first step, clearly, was to make one's self acquainted with all the various organisms, or forms, found in the fermenting mixture, and then to determine which were essential, and which (if any) were mere intruders or foreign organisms having nothing to do with the changes in question. It is equally clear that the only satisfactory way to accomplish this end was to separate and cultivate each form by itself, in a pure state. This entailed very numerous, and, in part, wearisome attempts, and the magnitude of the task is best understood from the fact that my notes refer to very nearly two thousand separate cultures, each extending over periods of from several days to months, and even in some cases to two years. Tiresome as some of the failures were, however, and especially those due to the interruptions inseparable from the conditions under which investigations must be carried on in a busy teaching laboratory, there is so much that is fascinating in such work, that it more than repays one for the trouble and disappointments, in the interest it excites.

METHODS.

During the whole course of the investigation, I have employed the usual methods of culture, but, as confidence in the results depends on the accuracy of these cultures, it may be advisable to give some general description of the details.

First, then, as to sterilisation. In all cases where it was desirable to ensure pure cultures, every flask, tube, funnel, watch-glass, glass-cell, cover-slip, slide, beaker, or other piece of apparatus was heated in a hot-air chamber to at least 140° C., for at least two hours, and in no case was reliance placed on any piece of glass that had not first been thoroughly cleaned, and thus baked. Moreover, everything was lifted by forceps similarly treated. In special cases the baking temperature was raised to 150° and even 200° , or kept up for several hours.

Before making the cotton-wool plugs for the tubes or flasks, the cotton-wool itself was always baked on several successive days and for several hours at 90° C., or for a shorter period at 120° C., and the baking repeated at least once. After plugging the flasks and tubes—already baked as above—with such cotton-wool, touched with sterilised forceps only, they were again slowly baked, if necessary, till the plugs began to colour.

The liquids employed as food materials were always prepared in sterilised stock-flasks, similarly plugged, and in no case used until they had been again heated to 90° C., or boiled, on at least two successive days; in the latter case so that the steam forced itself through the plugs for at least half an hour. The filling of the culture-tubes and flasks was done by means of sterilised funnels, and when filtering was necessary no filter paper was trusted that had not been baked and treated, like the cotton-wool, until the paper that enveloped it began to brown. Here, again, all contact with the hands was avoided by means of sterilised forceps.

After filling series of tubes or flasks with any given solution, they were allowed to stand, under a large clean bell-jar for a day (or two at most) and then either exposed for a couple of hours to 80° C. or 90° C., in the case of test-tubes, or placed on a sand-bath and boiled for a quarter of an hour; in some cases this was repeated after twenty-four to forty-eight hours. If on standing for three days or more I found the liquid or gelatine, &c., remained clear, the tube or flask was regarded as "safe." This "safety" was ensured by check-tubes by the side of the cultures.

As will be seen from the above, and from what follows, I employed three kinds of cultures. (1) Large cultures in flasks, usually liquids, but sometimes solid gelatine being employed; (2) smaller cultures in tubes; and (3) cultures in hanging drops, made in sterilised cells under the microscope.

The latter were ordinarily prepared as follows, everything being sterilised as already described, and nothing touched except by means of heated forceps:—

A deep glass ring was placed on a broad glass slide and a drop of previously sterilised olive oil allowed to run between, or melted paraffin was run in in the same

way while the slide and ring were hot ; this cements the ring to the slide. A large cover-slip is then placed flat on a support, and the hanging drop quickly put on and infected, and then, a drop of oil being placed on the upper edge of the glass ring, the cover slip is placed on this, drop downwards. The hanging drop thus projects from the thin glass roof into a practically air- and water-tight* sterilised chamber, and experience shows that such cultures will remain for at least a fortnight without danger of infection from without.

In special cases, especially where it was necessary to have control over the gases composing the atmosphere in the cells, I devised the following simple form of apparatus which has proved to be of the greatest utility for cultures of such organisms as the one under consideration, in hanging drops and in various gases under the microscope. In the working out and making of this instrument, I owe thanks to Dr. MATTHEWS and Mr. APLEYARD, and take this opportunity of acknowledging the debt.

Fig. 1.

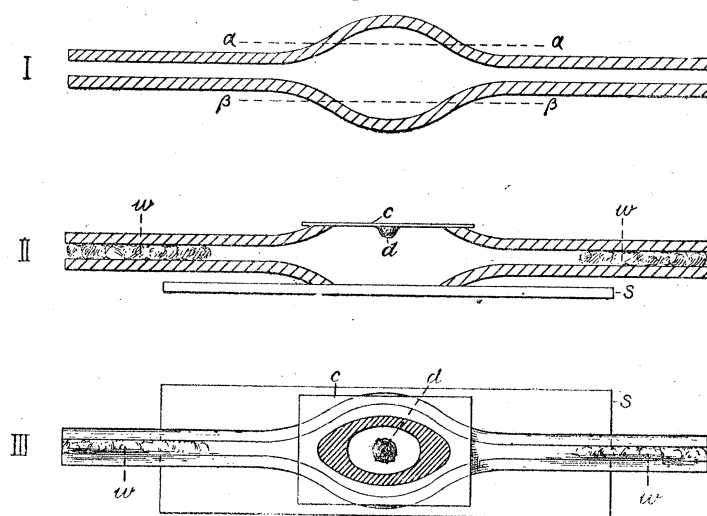

Glass culture-chamber for hanging drops. I., the tube ready for grinding, the glass being ground down to the levels *a, a, beta, beta*. II., side view of the chamber ready for use. III., view of same from above. *c* = cover-slip; *d* = hanging drop; *w* = cotton-wool plugs; *s* = ordinary glass slide.

Passing over the earlier attempts to improve on known forms of gas-chambers, the one ultimately adopted was the following. A piece of stout glass tube, about three inches long and as thick as possible, is carefully drawn out at both ends, until it looks like fig. 1 (I.). The narrow tubes must not be drawn thin, but the glass should be softened and allowed to contract the opening. The incomplete instrument now looks like a narrow tube with a bulb in the middle of its course (fig. 1, I.). The

* Practically so because the vapour-tension does not vary much in a laboratory at fairly constant temperature.

upper and lower faces of this "bulb" are now ground parallel, until the sides are perforated, as shown by the lines α , α and β , β , and the cell is ready for use. After sterilising, the lower pierced face is fixed by means of melted paraffin to a sterilised glass slide (*s*, fig. 1, II.). A sterilised cover-slip (*c*) with its hanging drop (*d*) is then fixed by means of freshly boiled oil to the upper face; and the two end tubes are plugged with carefully sterilised cotton-wool (*w*, fig. 1, II.).

Fig. 2.

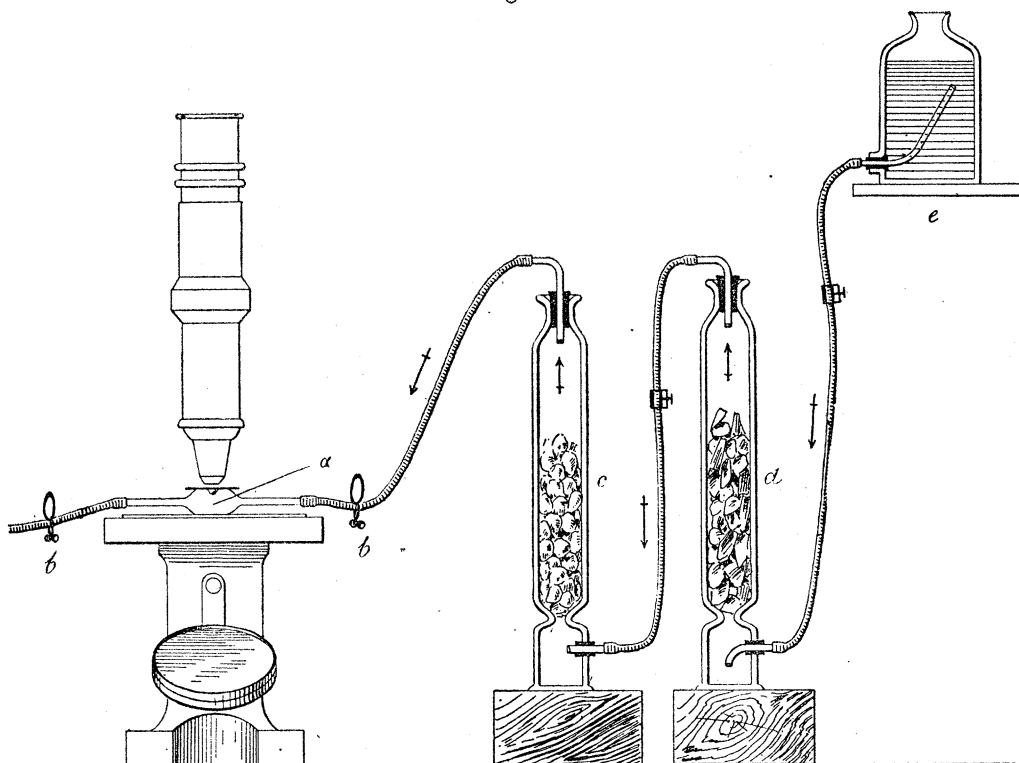

Glass micro-culture chamber in use with gas generators. *a* = the culture-chamber, with hanging drop, in position on the microscope; *b*, *b*, brass-clips on caoutchouc tubing attached to the plugged tubes of the culture-chamber; *c*, washing apparatus through which the gas generated in *d* passes before going into the culture-chamber (see arrows); *e*, vessel containing dilute hydrochloric acid, for evolving carbon dioxide gas from the marble in *d*.

It depends on circumstances what further procedure is adopted, but I protect the open ends of each glass tube with a piece of caoutchouc tubing (sterilised in corrosive sublimate and then washed and boiled) governed by a brass clip. To prevent evaporation the cotton-wool is moistened. Obviously any convenient form of gas-generator can be attached, and the accompanying wood-cut shows the apparatus arranged for cultures in carbon dioxide. (See fig. 2.)

Now as to the nutritive media, and the methods employed to obtain pure cultures. Those most commonly employed have been the following:—

(1.) Pure gelatine, made by boiling the best gelatine in distilled water, so that when "set,"* the medium contains from 5 to 20 per cent. of the gelatine.

(2.) Pure starch-paste, prepared by slowly boiling from 5 to 20 grms. per 100 of water.

(3.) Yeast-water, made by pounding up pressed yeast† in cold water in a mortar, filtering, and then sterilising by successive boilings. The proportions of yeast to water were 50 grms. to the litre, and reduced by boiling to one-half.

(4.) "PASTEUR'S (or MAYER'S) solution," of which I have employed three varieties, according as cane-sugar, glucose, or milk-sugar were used under the heading sugar. The constitution of "PASTEUR'S solution" is well known, but, to obviate misconceptions, I append the form of recipe used:—

	Grms.
Cane- (Grape- or Milk-) Sugar	150·00
Ammonium tartrate	10·00
Acid Potassium phosphate (KH_2PO_4)	0·20
Magnesium sulphate	0·02
Calcium phosphate	0·02
Water	1000·00

In later cultures I found it advisable to add 1 grm. of asparagin to the above. In my notes I refer to these solutions as Pasteur-glucose, Pasteur-milk-sugar solutions, &c., according to the sugar employed.

(5.) Ginger solution. During one stage of the researches, I found it was necessary to employ solutions containing ginger.

In view of the fact that ordinary decoctions of ginger rhizomes, crushed or whole, present difficulties in sterilising, I began by using the well-known "preserved ginger" obtained in jars from the grocer's, making up solutions containing from 5 to 20 per cent. of the syrup or the rhizomes. It turns out, however, that this confection is made from a species of *Alpinia*,‡ and not from *Zingiber*. Latterly, therefore, I made up solutions as follows:—

* In all cases a measured excess of water is allowed, because of the loss during the successive boilings.

† There is always a certain quantity of starch present in the commercial "German yeast."

‡ See the "Kew Bulletin," 1891, p. 5.

	Grms.
Crushed Ginger	10·0
Cane Sugar	40·0
Tartrate of Ammonia	1·0
Asparagin	1·0
Acid Potassium phosphate	0·5
MgSO ₄	0·25
CaCl ₂	0·25
Tap water	400·0
Liebig's extract of meat	Traces.
Peptone	„

In special cases I added from 2·5 to 5 or 10 per cent. of gelatine to the above solutions of yeast-water, ginger, sugar, and so forth, and found the following very convenient media for particular purposes:—

(6.) PETER's gelatine:—*

	Grms.
Gelatine	5
Glucose	3
Peptone and extract of meat	Traces.
Water	100

(7.) Also a solution of glucose, stiffened with gelatine (2·5 to 5 per cent.):—

	Grms.
Glucose	10 to 15
Gelatine	2·5 to 5
Asparagin	0·25
† HAYDUCK's mineral solution	5

(8.) For certain special cultures, especially of pure yeasts, the following, which I term HAYDUCK's solution, was much used:—

	Grains.
Cane sugar	10
Asparagin	0·25
† Mineral solution	5

(9.) The following was employed under the name HAYDUCK's ginger gelatine:—

* See 'Botanische Zeitung,' 1889, col. 414, foot note.

† This consists of—

	Grams.
Tap Water	100
KH ₂ PO ₄	50
MgSO ₄	17

	Grms.
Distilled water	100
Preserved ginger	10
Glucose	5
Asparagin	0·25
Gelatine	1
Mineral solution (as before)	5

(10.) The following "Bouillon" was much employed in the later researches on the Schizomycetes. One pound of lean beef-steak, chopped fine, was soaked over night in 1 litre distilled water, then filtered and boiled for half an hour. After filtering this was exactly neutralised with an alkaline mixture of sodic hydrate, sodic carbonate, and sodic phosphate, and again boiled for one hour. The clear pale straw-yellow *bouillon* thus obtained was boiled for twenty minutes, or heated to 90° C. for at least an hour, on each of four successive days, and then used.

In special cases 5 to 10 per cent. or more of sugar or PASTEUR'S solution was added to the above. I simply call these media *bouillon*, bouillon-sugar, bouillon-Pasteur, and so on.

It remains to describe the method of infecting and of obtaining pure cultures of the various organisms to be described.

In all cases I started with what may be termed preliminary cultures. A small portion of the presumably mixed mass of Yeasts or Bacteria, or both, was placed in a sterilised flask of the given solution, and left for 24 to 48 or 64 hours in the incubator, at a suitable temperature. By that time (or in some similar period) one or other of the organisms would be sure to have commenced budding or dividing, as the case might be, more rapidly than others: a small drop of the culture liquid now used for a second infection in a new flask, placed in like circumstances, now enables us to obtain the given form in yet greater predominance, and by repeating this a sufficient number of times (depending on the temperature, the medium, &c.) it is possible to obtain at least a flask or tube in which the particular organism favoured abounds almost to the exclusion of all others.

In order to be sure of what happens at each successive infection, I proceeded as follows:—First, I should state, all infections were made with *newly* drawn glass capillary tubes, none of which were employed again; these are more convenient than platinum wire, and equally safe if properly made and used. A drop having been secured at the drawn end of the tube—the thick part of which is not yet cool—I touch the liquid to be infected, and at once plug, label, and place in the incubator. Then I examine under the microscope what remains in the capillary, and which is, of course, a fair sample of what has gone into the new culture.*

* These are modifications of the "fractionating" methods of KLEBS ('Arch. f. experim. Pathol,' vol. 1), LISTER ('Pharm Journ.,' 1877, pp. 285-6), and NÆGELI ('Unters. ü. niedere Pilze,' 1882.

The next step—in some cases employed forthwith—was to obtain pure cultures from these roughly purified ones, and here the well-known methods of BREFELD, DE BARY, KLEBS, KOCH and HANSEN* were used.

My procedure was as follows, tubes of gelatine, or of nutritive fluids solidified with gelatine, were infected by streaking the fine capillary infecting tube over their surface, and specimens from the separate colonies which made their appearance after a few days were isolated by re-infection; then, when a culture had been got as pure as possible, I diluted a small quantity of it in a suitable nutritive medium to which enough gelatine was added to just stiffen the mass when cold, and prepared a hanging drop culture of this. In special cases, and always where the final pure culture was to be obtained in the case of the yeasts, I persevered till the hanging drop contained *only one yeast-cell*.†

The advantages of this method are obvious. In the first place, it is possible to follow the behaviour of the cell under the microscope, and to make drawings of the *same* object in successive stages, because the gelatine holds it in position all the time. Secondly, a culture of guaranteed character and purity can be prepared from the colony which results sooner or later from the budding of the yeast, by merely touching it with a capillary pipette and infecting a flask or tube. And, thirdly, the culture so obtained is known to be derived from *a single progenitor*, the behaviour of which is definitely known.

This method is less readily applicable in detail to the study of the Schizomycetes; although I have succeeded once or twice in isolating a single bacterium in a very small drop, it was necessary in most cases to work with drops containing several specimens relying on the fact that, in some cases at least, the gelatine keeps the specimens fixed. But although it is not easy to obtain a colony of bacteria derived from one thoroughly isolated progenitor, it is comparatively very easy to obtain pure cultures by means of the above method.

The pure culture once obtained, all else is a mere matter of time, and of discovering the proper environment for the organism.

For the study of the fermentations on a large scale, I found the following method very convenient. A common soda-water bottle is sterilised by heating, and its cork (a new one) soaked for several days in an alcoholic solution of corrosive sublimate, and then for a day in absolute alcohol, and then boiled for at least one hour on each of two successive days; this cork is perforated previously, and kept below the surface of the water by a piece of glass rod.

* It does not appear to be generally known that the botanists BREFELD and KLEBS devised the method of cultivating on solid media, by means of gelatine; though KOCH improved the method, and his especial merit consists in his perfecting it for the isolation of the colonies developed from mixed germs. A fair note on the subject is given by HUEPPE, 'Die Methoden der Backterien-Forschung,' 1885, p. 102.

† See HANSEN in 'Zeitschr. für wiss. Mikroskopie,' 1884, vol. 1, p. 191.

The soda-water bottle is then properly charged, the infecting organisms added, and the cork pushed well home by means of the glass rod. A manometer tube is then added, the end which pierces the cork being sterilised by heat and plugged with sterilised cotton-wool. (See fig. 3.) When the fermentation is an active one, as in the case of a yeast, there is at first considerable absorption of air, and the mercury rises in the proximal leg; after a few hours, carbonic acid gas is evolved, and presses the mercury forward; finally, the whole column is supported in the distal leg of the manometer, and the bubbles of gas escape at intervals. The number of bubbles per minute (other things, such as temperature, pressure, &c., being constant) gives a good approximate measure of the rate and activity of the fermentation. I have also employed modifications of this method, the details of which will be mentioned in their proper place.

Fig. 3.

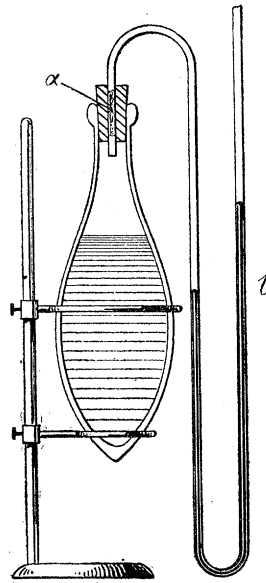

Soda-water flask arranged for fermentation experiment. *a*, plug of cotton-wool; *b*, mercury in the manometer tube.

THE VARIOUS ORGANISMS FOUND IN THE GINGER-BEER PLANT.

As will have been gathered from what has been said, the Ginger-beer Plant is a composite body, consisting of several organisms, or, at least yielding more than one definite organism. Investigation has shown, however, that while two specific Cryptogams constitute the ginger-beer plant proper, and are necessary for its formation and peculiar action, the rest are merely accessory or foreign organisms, doubtless due to the admixture of spores from outside. Of these there are also two which are so constantly present, that I was for a long time in doubt as to their true relations: the

remainder only occur occasionally, and are certainly intruders, such as might be expected to occur in such a heterogeneous mixture, exposed to air and made with ordinary water, as the usual "brew" of "home-made ginger-beer" is. In fact, any fungus or Schizomycete that will grow in a saccharine solution at ordinary temperatures, might occur in the exposed fermentations. I have confined my attention only to the forms usually met with.

Of the two essential forms, one is a species of *Saccharomyces*, which turns out to be a new species, and which I shall have to name; the other is a Schizomycete, and is also a new and very remarkable species, and must be named.

Of the two constant, but not essential forms, found in all the specimens examined, one is a yeast-like form, which turns out to be *Mycoderma cerevisiæ* (DESM.), the well-known agent of the "mould"* on sour beer, &c.; while the other is the vinegar *Bacterium*—*Bacterium aceti* (KÜTZ.),—equally well known as the principal constituent of the "Vinegar Plant."

The foreign intruders most commonly met with are species of *Saccharomyces*, *Bacillus*, *Micrococcus*, *Oidium*, *Torula*, *Dematium*, and one or two ordinary mould fungi, of which *Penicillium* is by far the commonest.

I shall describe these organisms in the following order:—First, the *Saccharomycetes*; secondly, the *Schizomycetes*; and lastly, the various fungi of other kinds, and shall prefix a letter to each species in order that reference may be simple and certain.

Yeast A.

Saccharomyces pyriformis (n. sp.). (Plate 11, figs. 1-10.)

This yeast, the most important of the forms met with in this investigation, has now been found to occur in every specimen of the Ginger-beer plant that I have examined, and there can be no doubt that it is *the* yeast principally concerned in the fermentation of ginger-beer.

I first brought it into pure cultivation in 1889, and was at once struck with its general resemblances to the bottom-yeast of some of the Continental wine fermentations (*S. ellipsoideus*).

It induces active fermentation in sugar-solutions, whether prepared with cane-sugar, syrup, or glucose, resulting in a copious evolution of carbon dioxide gas, and in the formation at the bottom of the flasks, tubes, &c., of a voluminous white pasty deposit, consisting of characteristic colonies of budding yeast-cells.

Pure cultures were readily obtained, both by the dilution method, of successive transference from flask to flask, and by growth on gelatine media; from such cultures

* The "*Kahmhaut*" of the Germans.

I got single cells to grow in hanging drops of various saccharine solutions, stiffened with about 5 per cent. of gelatine, in sterilised cells under the microscope.

The single cell is globoid, or more commonly ellipsoid, or ovoid in shape, colourless and translucent, and measures from 6 to 7 μ long \times 5.5 μ broad, though smaller and larger cells are found.

It buds readily at all temperatures from about 10° C. to 35° C., and very actively at about 25° C. Cultures in pure gelatine (that is, nothing added except the traces of saccharine carried in by the yeast-cells) compressed between a cover-slip and glass slide (all sterilised) also showed that the completely submerged cells can bud at from 11°·5 C. to 14° C., as shown in Plate 11, fig. 5, though, of course, the process was somewhat slow; nevertheless, even large colonies, of several hundred cells, were obtained in three or four days.

The ordinary behaviour of the cells in hanging drops of ginger-gelatine is well shown in fig. 6, Plate 11. The isolated ellipsoidal cell contains a large vacuole, enclosed excentrically in pale finely granular protoplasm. Its budding, which usually occurs at or near one end, may begin in about three hours after the preparation of the culture, and soon results in the completion of the daughter-cell; meanwhile, a second bud may appear at or near the opposite pole, and each daughter-cell soon repeats the process. The mother-cell may also give off other daughter-cells from various other points on its surface, and the process, even at low temperatures, soon becomes too complex to follow in detail, resulting in the formation of remarkably coherent colonies. (Plate 11, fig. 6, ϵ .)

There is no limit to the size and shape of these colonies, apparently, as the figures (Plate 11, figs. 5 and 6) sufficiently show, and they often grow to masses as large as a mustard seed, and perfectly visible to the unaided eye as white, opaque, dome-shaped, or spheroidal clumps at the bottom of the flask, or hanging drop, if kept perfectly quiet. (Plate 11, fig. 5.)

I have frequently taken advantage of the formation of these colonies in the hanging drops of nutritive solutions stiffened with gelatine, to transfer pure cultures—traced from a single cell—to sterilised flasks of PASTEUR'S or HAYDUCK'S or other fluids, or to gelatine tubes, &c. This is easily done by touching the colony with a freshly drawn fine glass capillary tube, and then infecting the culture flask, &c., employed.

One point of physiological importance is worth recording. In very active, vigorous cultures of this yeast, the protoplasm gives a strikingly clear glycogen reaction; on adding iodine dissolved in an aqueous solution of potassic iodide, the cells turn dark sienna red, or red-brown,* and the colour pales to yellow (or even fades altogether) on warming, to reappear on cooling.

Another point worth noting is the development of ascospores, which I have been able to observe repeatedly, and with singular distinctness, in this yeast. The development of the endogenous ascospores in *Saccharomyces* has been especially

* ERRERA, 'Bull. de l'Acad. de Bruxelles,' Nov., 1882.

studied by HANSEN,* who founds his definition of the genus and the distinction of species chiefly on this peculiarity. The yeast in question not only develops the spores when spread on moist and sterilised gypsum, but also very readily on the surface of solid sterilised gelatine, and I have been able to obtain beautiful preparations by this means, which can be stained by hot carbolio-fuchsin solution and mounted in Canada-balsam.

These spores begin to develop in from two to four days at 25° C., and this accords very well with HANSEN'S results (Plate 11, fig. 3).

I found that at 25° C., it required four days to obtain the complete spores on gelatine, in loosely plugged tubes; but on sterilised blocks of gypsum, white brick, &c., carefully moistened and fully aerated, the first indications of spore-formation were evident in thirty to forty hours, and complete spores were formed in forty-eight to fifty hours. This quicker development is no doubt due to the more perfect access of air and water to the cells. As HANSEN also showed, the cells employed must be at the height of their vigour, otherwise the spores are not developed.

The spores are almost invariably in fours, and arranged in a tetrad, so that the membrane of the parent-cell surrounding them is often pulled into a form approaching the tetrahedron. I have in vain attempted to follow the details of the spore-formation, and cannot decide whether ordinary division or any other method of separation of the protoplasm precedes the complete separation of the spores. Each spore, when ripe, is surrounded by a delicate, though firmly contoured membrane, and very little, if any, protoplasm remains unused.

The spores germinate fairly readily if they are completely ripe; drying seems to favour the process (fig. 10).

The germination consists simply in the swelling up of the endogenous spores to the form of the original yeast-cells, which then begin to bud in the ordinary manner of these sprout-cells. The sprouting may begin *in situ*, or the membrane of the mother-cell may be burst, and the spores set free, and then sprout, as shown in the figures.

Dilute solutions and plenty of oxygen are necessary for the free germination of these spores; they may be made to germinate in hanging drops stiffened with gelatine, but the process is slower. 25° C. is a good temperature.

Since it was necessary to have the opinion of practised brewers on the subject of this yeast, I asked my friend, Mr. HORACE BROWN, of Burton-on-Trent, to cultivate a pure sample of it, and to have it examined from the brewer's point of view. To Mr. BROWN and to Dr. MORRIS, who kindly did this and prepared photographs for me, I have to express my sincere thanks.

I sent the samples in the usual manner. Some of the fresh pasty deposit, of a pure culture, was smeared carefully on to the centre of a thoroughly sterilised filter-paper, which was then folded and wrapped in several successive papers similarly prepared.

* See JÖRGENSEN, "Die Mikro-organismen der Gährungsindustrie," 1890, for literature of whole subject.

To be quite certain that no accident had happened, I requested Dr. MORRIS to return me a similarly prepared sample of *his* cultures from the above; this he was so good as to do, and I again repeated my observations on Dr. MORRIS' samples (which had gone through five cultivations in beer-wort), and satisfied myself that the form had kept true throughout, the only point of difference I could detect being that the sojourn in beer-wort had slightly improved the average size of the cells, and this came down again in PASTEUR'S and HAYDUCK'S solutions as before.

Grown in hopped wort, the cells of the yeast range from 9 to 5 μ in diameter. A wort of specific gravity 1054.0 attenuated in twelve days to specific gravity 1022.7, and showed no further decrease at the end of fifty-two days. This attenuation corresponds to the production of 4.4 per cent. (by volume) of alcohol, and shows that, compared with some yeasts, the fermentation-activity (regarded as a means of obtaining alcohol) is not very great.

The young cells, lying on earthenware blocks, at 25° C., showed distinct traces of ascospores after twenty-four hours, and at the end of forty-eight hours many spores were formed; these increased in number up to the fifth day.

As already pointed out, HANSEN'S researches* have shown that when yeasts are allowed to ferment malt-worts in contact with air, the whole being kept perfectly still, certain modified growth-forms of the cells appear as films of great tenuity. These films arise on the surface of the liquid, in contact with air, and the cells composing them are of considerable importance in enabling us to recognise the species of *Saccharomyces*.

Grown in this manner in beer-wort, the yeast under consideration develops the aërobian form—or film-growth—in about three weeks; this continues during the next two or three weeks, until a complete skin is formed on the surface, and patches fall to the base of the flask in flake-like clusters.

The shapes of these aërobian cells (or “involution forms”) are shown in outline in Plate 11, figs. 8 and 9, and will be seen to be usually pyriform, or some modification of that figure.

If we take into consideration all the facts I have been able to elucidate about this yeast, and compare them with what is known of other species of *Saccharomyces*, it will be evident that my species is one allied to *S. ellipsoideus** (as amended by HANSEN), though not identical with it. Dr. MORRIS writes of this form: “It was at first thought that it was the same as one isolated from the air by us, but the nature of the film-formation is opposed to that conclusion” . . . “It does not agree with any previously described.”

The species must, therefore, be regarded as a new one, and I propose to name it, from the characteristic pear-shaped aërobian cells, *Saccharomyces pyriformis*.

Its chief characters may be summed up as follows:—

A low, or bottom-fermentation, yeast, which inverts and ferments cane sugar.

* HANSEN, ‘Meddel. fra Carlsb. Labor.,’ 1886.

Ordinary cells ovoid or globoid, ranging from 5 to 9 μ in diameter, though smaller and larger ones occur.* Ascospores formed in from two to four days, at 25° C. and lower. Aërobian forms, as films, of pyriform, or sausage-shaped cells, developed in wort in twenty-one days. It occurs in "home-brewed ginger-beer," and is the predominant form in the so-called "Ginger-beer Plant."

Yeast B.

Mycoderma cerevisiæ (DESM.). (Plate 12, figs. 1-6.)

Whenever the fermentations were carried on or finished with access of air, a dense wrinkled skin ("mould") formed at the surface; and, since this occurred, when the air had to filter through sterilised plugs of cotton-wool, there can be no doubt as to the origin of the fungus from the infection. It is the very polymorphic *Mycoderma cerevisiæ* of DESMAZIÈRES.† It is not a true *Saccharomyces*, for it does not form ascospores, and differs in several respects from the true yeasts, in the narrow sense. It might be a matter for surprise that I should have devoted so much attention to so common a form were it not for the fact that such conflicting statements occur as to its nature and properties, and that it was necessary to be sure of its relation to the ginger-beer plant.

It is, indeed, one of the most variable of all the yeast fungi, and has been the subject of several extraordinary statements as to the vagaries of these fungi.

It makes its appearance invariably in the latter stages of all the preliminary cultures, and, in many cases, was the predominant form from the beginning.

I first had my attention attracted by it in the earlier cultures of 1887. On November 16 of that year, a flask of PASTEUR'S solution was prepared for rough separation cultures, and a lump of Ginger-beer plant put in. On the 30th, the liquid was covered with a characteristic yellowish, wrinkled skin. This skin began as a very thin iridescent pellicle, at first quite smooth and almost greasy looking; it then became thicker and streaky, looking as if made up of extremely fine sinuous silky fibrillæ; as its thickness and toughness increased, the silky fibrillar character became more pronounced, especially if caused to rock or sway as the flask was moved. At a later date, the surface became wrinkled, and, while this feature gradually intensified, the lower surface was thrown into irregular folds, reminding one of racemose glands hanging down into the liquid.

These characters are so unmistakable that any one can recognise the skin after a little practice.

Sooner or later, pieces of the submerged part of the very thick skin become detached and slowly fall to the bottom of the flask; and, as a rule, the colour becomes more and more buff as it ages.

* The cells grown in PASTEUR'S or HAYDUCK'S solutions are usually smaller than those in wort.

† *Saccharomyces mycoderma* (REESS), *Hormiscium cerevisiæ* (BONORDIN).

Many of the cells which fall into the liquid die, apparently from want of oxygen; but this is by no means the case with all, and, although *Mycoderma* is distinctly an aërobian form, I have nevertheless got it to grow in hanging drops of gelatine—where the supply of free oxygen must, at most, be very limited, and even in gelatine, compressed between a cover-slip and a glass slide—where the access of oxygen must have been reduced almost to a minimum.

This *Mycoderma* is particularly apt to form in the preliminary cultures made at *low* temperatures—12° to 15° C.—and especially when glucose is employed instead of cane-sugar, though (still with reference to the preliminary cultures) it is by no means slow to appear on ordinary PASTEUR'S solution. These facts are quite in accord with HANSEN'S statements* that *Mycoderma* is unable to invert cane-sugar or to bring about its fermentation; and that it is apt to appear on lager beer even in the cold cellars.

In illustration of its well-known ubiquity, I may mention that whenever a piece of unsterilised ginger was used, or a mass fermentation allowed to go on in open vessels, and so on, this form invariably made its appearance at ordinary temperatures. At higher temperatures, however—*e.g.*, 30° C.—it was often kept in abeyance, even in the separation-cultures; this was not because the *Mycoderma* will not grow at 30° C., but because it suffered in the struggle with competing forms. Sooner or later, when the dominant fermentation was finished, it invariably manifested itself if present. It was much more difficult to prevent it gaining the upper hand in glucose solutions than in those where cane-sugar was employed.

Some of my experiments go to show that *Mycoderma* does not long preserve its vitality. Infections made in glucose solutions in May, 1890, from flasks kept since the preceding November, remained without effect for three weeks.

In older cultures of the *Mycoderma* on PASTEUR'S solution made with glucose, I have several times noticed a peculiar strong odour, like that of rancid olive oil; what changes have gone on to produce this, or what the odour is due to, I have been unable to discover exactly.

This *Mycoderma* yeast is very easily obtained in large quantities, and therefore easily got pure by repeated successive infections of glucose solutions.

The skin is then found to be composed of dense colonies of elongated cells, the budding of which takes place with great regularity, and usually in the order shown in Plate 12, figs. 1–3. The first cell puts forth a sprout at its apex, and then one at each side just below the sprout, and as each succeeding sprout behaves in the same way, we have curious racemose or dendritic colonies produced. In other cases the lateral sprouts are alternately suppressed on either side; or all occur on one side only. Finally, cases occur where the cells are very long and bud so as to produce net-work-

* HANSEN in 'Annales de Micrographie,' Paris, 1888; No. 2, p. 8.

like colonies. These peculiarities had already been noticed by CIENKOWSKY,* and WINOGRADSKY† has also remarked the great variability of this yeast.

In spite of several statements to the contrary, this *Mycoderma* seems to be devoid of the power to form spores. I have utterly failed to induce the formation of the endospores by any of the received methods. In this, my results confirm those of ZOPF‡ and HANSEN,§ and are opposed to those of DE SEYNES,|| ENGEL,¶ REESS,** and CIENKOWSKI,†† and accepted by DE BARY.‡‡

In considering this matter, which of course affects the question of priority as to the discovery of the ascospores in *Saccharomycetes*,§§ it should be remembered that (1) it is probable that all the earlier observers worked with mixed yeasts, since the methods of separating and obtaining pure cultures were entirely modern; and (2) it is often easy to mistake oil-globules in the cells for spores, although, of course, the latter error is less likely, in the case of the experienced observers mentioned, than the former.

CIENKOWSKY describes long branching mycelial forms of *Mycoderma*, and seems to regard *Oidium lactis* and *Chalara mycoderma* as both genetically connected with that form. In this I fail to confirm his statements, so far as *Oidium lactis* goes (I have not met with *Chalara*), and am the more disposed to think he was working with mixed species, because I have separated the *Oidium* and the *Mycoderma* from one and the same flask, and kept them going separately under similar conditions, and their differences remained constant.

The average size of the cells||| is 6 to 8 μ long, by 2 to 4 μ broad, and there are several peculiarities which characterise them, much as they vary when cultivated on different media.

In the first place they are particularly apt to have air entangled among them, thus giving a peculiar lustre to the films, and offering some difficulties in manipulation under the microscope. (Plate 12, fig. 2.)

Again, as has long been known, they often contain one or more very highly

* 'Mélanges Biologique, de l'Acad. de St. Pétersb.,' vol. 8, p. 566.

† 'Bot. Centralbl.,' 1884, vol. 20. In view of its great variability, I would suggest that this form is worth renewed comparative study from the point of view introduced by ELFVING and LAURENT, see footnote, p. 180.

‡ SCHENK'S 'Handbuch der Botanik,' vol. 4, p. 747.

§ Cited by JÖRGENSEN, 'Die Mikro-organismen der Gährungsindustrie,' Berlin, 1890, p. 154.

|| 'Ann. Sc. Nat. Botanique,' vol. 10, 1869.

¶ 'Les Ferments Alcooliques,' 1872.

** REESS, 'Bot. Unters. u. d. Alkoholgährungspilze,' 1870.

†† CIENKOWSKI in 'Mélanges Biol. Akad. d. St. Petersb.,' 1873, vol. 8, p. 566.

‡‡ 'Morph. and Biol. of Fungi,' pp. 268-9.

§§ If the bodies DE SEYNES observed in *Mycoderma*, or other yeast, were spores, the credit of discovery belongs to him ('Comptes Rendus,' 1868, vol. 67.)

||| The small rounded forms are about 2 to 3 μ in diameter.

refractive bodies, probably oily in nature, floating loosely in the vacuole (see figs. 4 and 5, Plate 12); while the cell, as a whole, is less translucent than an active *Saccharomyces* cell. The fact of *Mycoderma* usually appearing at or near the end of a fermentation, depends partly on the absence of oxygen during the activity of the yeasts in the liquid, and partly on the domination of the principal form at the time. It was always easy to suppress the *Mycoderma* in my cultures by putting the tubes, flasks, &c., into an atmosphere of hydrogen or carbon-dioxide. I suppose this is because the *Mycoderma* is aërobian, though, as already stated, it can be grown (in pure cultures) under circumstances where very little free oxygen must exist.

Yeast C.

Cryptococcus glutinis (FRES.*)?. Plate 12, figs. 7-10.

This is a pink or rosy yeast-like organism, and one of the most beautiful and interesting of all those I have examined. Though fairly well characterised by the sum of its properties, its variability is so remarkable that no one would be justified in regarding the different phases as belonging to one and the same object unless he traced their connection by continuous cultures, as I have done. It came under closer investigation in a culture of October 21, 1889, and I have had it separated and in regular laboratory observation for several months.

In some of the preliminary cultures of 1889, the flasks of PASTEUR'S solution were found to contain rosy-pink specks in the thin buff skin which commonly formed in from two to three days, at temperatures varying from 56° to 130° F. This was especially the case with a set of preliminary separation cultures of the Ginger-beer plant sent me from Kew, and said to have been originally derived from South America.

The pink flecks soon spread, invading the other yeasts of the skin, and since they appeared in from 7 or 8 to 20 or 21 days, and also in other cultures derived from England (*e.g.*, in specimens from Mr. LEETE) it may be assumed that the original germs were in the specimens from the first.

These pink flecks and patches appeared thus spontaneously, so to speak, only in the flasks of PASTEUR'S solution, but subsequent experience showed that it will grow admirably in and on glucose solution.

Although there is sufficient evidence to justify the conclusion that this organism was introduced as a constituent of the above-named specimens of the Ginger-beer plant, it is equally certain it is not a necessary part of it: on the one hand, I have repeatedly failed to find it in cultures of the "plant" obtained from some of the other

* I have put a ? to this because it is not certain that the form described by FRESSENIUS is the same as HANSEN investigated, as will be seen.

sources, and, on the other, I once obtained it under circumstances which strongly indicated its introduction as an adventitious germ from the air of the laboratory.*

All things considered, therefore, it may be regarded as a foreign or wild form, sometimes occurring as an impurity in the lumps of Ginger-beer plant, but in no sense indispensable to the mixture. It is, nevertheless, sufficiently important to be recorded and described as far as possible, and particularly interesting because I have succeeded in eliciting some new discoveries concerning it, and its probable systematic position.

The yeast of the pink patches was easily isolated and examined, and was found to be a form very variable in size, shape, and other characters. (Plate 12, figs. 7 and 8.)

Many of the cells were merely ellipsoidal and regular, but others were provided with short, sharp spine-like processes, while others again were drawn out here and there into thin hypha-like arms, simple or branched, and presented a striking similarity to germinating spores.

The rosy-pink colour is totally invisible in the thin layers used under the microscope, the delicate cells appearing peculiarly hyaline and watery, partly owing to the extreme tenuity of the cell-walls, and partly to the large vacuoles and very watery protoplasm: the cells are, in fact, so delicate that they seem almost transparent (Plate 12, figs. 7 and 8), and it would not be impossible for a careless observer to overlook them. The rosy hue is only evident when large numbers of the cells are together, forming a thick mass. I have not investigated the colouring matter, nor have I made measurements as to the thickness of layer necessary for its observance.

The average size of the cells, when in the typical oval yeast-form, is about $9\ \mu$ long by $4\ \mu$ broad; but they may be as much as 10 or $11\ \mu$ in diameter when the more irregular shapes shown in figs. 7 and 8 are assumed.

As already stated, a characteristic feature of this yeast is its extreme delicacy: not only is the cell-wall extremely thin and transparent, but the protoplasm is peculiarly hyaline and watery, and very large clear vacuoles are apt to form in it. One consequence of this, and favoured by the irregular shapes of the cells, is a certain resemblance to an *Amæba*, but no motion of translation or pulsation of the vacuoles is observable, and the comparison is entirely superficial, and as regards the mere outlines.

The cells bud like an ordinary yeast-cell, either from some point on the surface of the elliptical regular cells, or from the tips of the sharp spine-like or the longer arm-like protuberances.

Cultures in various media have convinced me that this yeast does not induce alcoholic fermentation; it is distinctly aërobian, and, since every effort to make it develop endospores has been without success, I regard it as not a true yeast at all—*i.e.*, as not a *Saccharomyces*. Indeed, the only feature it has in common with the

* It has long been known that a rosy yeast can be obtained from air (see CROOKSHANK, 'Manual of Bacteriology,' p. 342).

true yeasts is its habit of budding, unless we regard the forms of its cells as comparable to the aërobian forms of some species of *Saccharomyces*. However, I am, fortunately, in a position to give much better evidence than the above in support of my contention that this pink yeast is no *Saccharomyces*, and not even the aërobian form of one.

Before doing this, it will be well to state what I have been able to find out about the "rosy" or "pink" yeasts in the literature: this is not very much.

So far as I have been able to discover, the only distinct references to pink yeasts, are in BREFELD,* COHN,† and HANSEN,‡ and, unfortunately, the latter is in Danish, and I cannot read it in full detail. Some of HANSEN'S figures are sufficiently characteristic, however, to make it very probable, indeed, almost certain, that his "*Rodtfarvede gjærsvampe*" and my rosy yeast are one and the same form, a conclusion that is fully borne out by the glimpses into the meaning of the text which I have been able to get with the aid of German.

As regards the other references, they are so incomplete that they afford very little or no help to us. FRESSENIUS§ gives a note on a red yeast, which he named *Cryptococcus glutinus*, and COHN'S form is the same, though the latter altered the name to *Saccharomyces glutinus*. The question then arises whether this form is the oval regular form of HANSEN'S and my rosy yeast. Unhappily, I cannot get at HANSEN'S opinion on this point, but it is, at least, likely that what FRESSENIUS and COHN described is simply the young stage of our rosy yeast. This matter of species determination, however, is hardly worth following out in the present state of our knowledge; the ordinary descriptive fungus floras abound with mere names of yeasts and bacteria, and are useless in this connection. I have, therefore, contented myself with recording all I could find out about my rosy yeast, and leave the question of its name and synonymy to others. New light was thrown on the question by cultures in sterilised extract of beet-root, stiffened with 5 per cent. of gelatine. In the hanging drops, arranged in large cells and with abundance of fresh air, I obtained excellent results, which will be best illustrated by a concrete case (see Plate 12, fig. 10, *a-g*).

On the 15th March, a few cells from a pure culture of the rosy yeast, were transferred to a large drop of the beet-gelatine on a sterilised glass plate, and a small hanging drop culture was prepared from this. When I had succeeded in obtaining a satisfactory drop, containing only *one* cell, it was fixed under the microscope and then sketched (fig. 10, *a*). This was at 10.30 A.M.; the thermometer stood at 12° C. At noon of the same day, this cell had commenced to put forth a protuberance at the lower rounded end, and by 12.30, this was sufficiently distinct to be shown in a drawing (*b*), while, at 4 P.M., it had become as large as the parent cell.

* 'Landwirthsch. Jahrb.,' vol. 5, 1876, p. 339. Taf. ii., fig. 10.

† 'Beiträge zur Biologie der Pflanzen,' vol. 1, Heft 2, 1872, p. 110 and p. 187. Taf. iii., fig. 6.

‡ 'Organismer i Öl og Ölurt,' Copenhagen, 1879.

§ 'Beitr. zur Mykologie,' 1850-63, p. 77, Taf. viii., figs. 43-46.

(c) The further progress of events is evident from the succeeding figures. During the night, the cell budded off, on the 15th separated, and at 9 A.M. on the 16th, a new one was being formed near its point of origin (fig. 10, *d*); to this a third was added by 6 P.M. (*e*), and considerable progress was made during the ensuing night, owing, probably, to the slight rise of temperature which occurred in the laboratory. In fact, by 10 A.M. on the 17th, quite a colony of budding cells was formed (*f*), and this continued up to 4 P.M. (*g*). By this time, however, a change was noticed in the behaviour of some of the cells, which were beginning to elongate. On the morning of the 18th, the temperature being still 15° C. as on the preceding day, the cells had put out long hypha-like arms, some of which produced terminal cells, like budding conidia, as shown in fig. 10, *h*. At *i*, *k*, and *l*, are shown the stages of further development of the hypha marked \times in *h*; while at *m* is a characteristic group of these conidia-bearing hyphæ. That they are to be regarded as conidiophores is evident from their further behaviour, and from *n*, which is one of the bud-conidia detached and germinating.

From the colony (shown in *h*) of March 18th arose the dense radiating mycelium shown in *o*, which represents the state of affairs on March 21st; the small dots shown in this figure (drawn to smaller scale) are the above-named conidia, and two of the conidiophores are shown at *p* and *q* on a larger scale. In the dense centre of the radiating mycelial mass the pink hue is now quite evident.

Obviously, the well-nourished "rosy yeast" has developed into a true hyphal fungus, with septate filaments and conidia, and the next step is to see what it is most like: clearly it is not like any yeast known to us, and we must look for its allies among some of the higher forms. For my own part, I cannot help being struck with the general resemblance between my figs. *m*-*q*, and some of the conidial forms of the *Basidiomycetes* lately described by BREFELD*, and although several links are required before this form can be definitely allied with the *Basidiomycetes*, it seems probable that the common "rosy yeast" is a mere growth form of some member of that group.

Yeast D. (Plate 15, fig. 10.)

In some of the earlier separation cultures, I frequently met with a small yeast, the cells of which were very nearly spherical, and averaged about 2.3 to 3.7 μ in diameter, and appeared in remarkably dense, white, dusty looking films on the top of the culture liquids: these films were so like flour in appearance that I habitually referred to this form in my notes as the "floury yeast."

I have made no very extended cultures of it in detail, because, as stated on p. 138, I found that it was not a normal constituent of the Ginger-beer plant; but one or two interesting facts about it came to light during the examination of the pure cultures, and those may be put forward in the hopes that further investigations may

* 'Unters. aus d. Gesammt. Gebiete d. Mykol.,' 7 and 8, 1888-89.

be undertaken to clear up its life-history, &c. Owing to the gaps in my knowledge of its characters—*e.g.*, as to whether it forms spores—it seems unadvisable to give it any specific name.

In the first place, it is aërobic in a marked degree, forming a pure white floury film on the surface of the culture-liquids: this film creeps up the sides of the tubes several millimetres beyond the general level of the medium, and has a dull dusty appearance, as if the liquid did not wet it.

It developed an evident fermentation in HAYDUCK'S solution, and in sugar solution to which ginger had been added, but it seemed to grow best in glucose solutions. I could not get any material results on gelatine; it neither liquefied the medium nor grew to any marked extent on it.

I have already referred to its association with the acetic *Bacterium*, and the production of acetic ether in those flasks where both organisms co-exist. In some cases I noticed a pressure of carbon dioxide sufficient to blow the corks from the culture-flasks, and everything points to it being capable of inducing alcoholic fermentation.

The yeast in question develops characteristic colonies, in chains, as shown in Plate 15, fig. 10, and if reliance may be placed on these morphological characters, it is the same as a form isolated from a bottle of "home-made ginger-beer" in 1890, where, mixed with several forms of other yeasts and Schizomycetes, it was relatively abundant.

OTHER YEASTS.

In addition to the foregoing, I occasionally found the ordinary beer-yeast (*Saccharomyces cerevisiæ*) and two other forms which I have been unable to identify with certainty, though one of them is probably *S. apiculatus*. Since these were rare, however, and were obviously not concerned in the formation of the Ginger-beer plant, I did not follow out the details of their life-history. I kept them in cultivation for a few months, and even made a few cultures of them in company with *Bacterium vermiforme*, but the results do not require detailed description.

Schizomycete No. 1.

Bacterium vermiforme (*n. sp.*). (Plates 13 and 14.)

Of the several Schizomycetes met with during the course of this investigation the one constant and essential form—essential because the Ginger-beer plant cannot exist as such without it—is a peculiarly vermiform organism, enclosed in hyaline, swollen, gelatinous sheaths, and imprisoning the yeast-cells of *Saccharomyces pyriforme*, &c., in the brain-like masses formed by its convolutions. It is the swollen sheaths of this organism which constitute the jelly-like matrix of the "plant." Of course my

attention was particularly directed to it from the first, and its vagaries, indeed, have been the chief puzzle throughout; for while, on the one hand, it is singularly responsive to changes in the environment—nutritive materials, the gases composing the atmosphere, &c.—it is, on the other hand, so remarkably polymorphic that it was impossible to trust the mere tube- and flask-cultures without full confirmation from cultures in hanging-drops under the microscope, and since these can only be carried out with the expenditure of much time and trouble, involving numerous failures before success was attained, it will readily be understood that results could only be got slowly in a busy teaching laboratory, where the intervals necessary for continuous observation cannot be arranged during term.

Fortunately, although this *Bacterium* is so variable in its behaviour according to the conditions of its environment, it is by no means a sensitive or delicate organism in other senses; it can be dried and kept for long periods, and is obtainable in any quantity at short notice.

When the contents of a suitably prepared fermentation-flask, in which the Ginger-beer plant has been acting for about three days, are examined, several objects are noticed besides the yeast-cells. I am here assuming that the culture is pure, though, of course, that had to be tested in the actual investigation.

The commonest types of these objects are shown in figs. 3-6 of Plate 13. It depends on the stage of the fermentation which one predominates, but in a third day fermentation of PASTEUR'S solution (with asparagin and ginger) large numbers of pale, glassy-looking spheroidal, egg-shaped, rod-like, or filamentous, coiled, curved, or variously twisted bodies will be seen floating in the liquid (figs. 3, 4, 6); these vermiform bodies present two modifications. Some of them are perfectly homogeneous throughout (figs. 4 and 5); these may be long or short, straight, curved, or twisted in all kinds of ways, and as they roll over, the observer can assure himself that they are all modifications of a sausage-shaped or cylindrical form. They have a curious lustre, and are easily overlooked in some lights, though the brilliance due to their moderately high refractive index usually picks them out in some part of the field.

Careful observation shows that others of these bodies are not homogeneous, as the above, but contain specks, rodlets, or filaments of much more refringent substance in their interior (Plate 13, figs. 6-8, and Plate 14, figs. 3-5). These contents (whether specks, rods, or filaments), are not necessarily symmetrically disposed in their investing substance; they may be central in the latter, or axile, and equidistant from the contour throughout, and following all the coils, turns, twists, &c. of the investment (Plate 13, figs. 6 and 7); or the specks, rodlets, or filaments may be excentric (Plate 13, figs. 6, *c*, and 8) or partly exerted (fig. 6, *b*), or absent from one part or the other. It will simplify matters if I say at once that the brilliant refractive contents, just described, are the *Bacterium* we are concerned with, in various stages of development; while the paler investment is a peculiar swollen gelatinous sheath, which envelopes the organism.

Mingled with the objects referred to are large numbers of minute spheroidal specks, and rods of various lengths, and perhaps (but not always) some longer filaments—in fact, cocci, bacteria, bacilli, and leptothrix-forms, &c., to use the current phraseology. These are unquestionably naked* Schizomycetes (Plate 13, figs. 3 and 8) from their form, reactions, the stages of division which they present, and from their behaviour in cultivations.

It is now easy to see how natural were the questions—Have these naked forms anything in common with the sheathed cocci, rodlets, filaments, &c., above referred to? Are they, in fact, merely the Schizomycetes escaped from their investing sheaths; and are the homogeneous structures, first described, merely the empty sheaths?

As a matter of fact this is the case; but it will readily be understood that such a conclusion could not be taken for granted, and several other questions had to be propounded and answered before these facts were demonstrated, and the first and most obvious of such questions was, are all these variously-shaped naked bacteria different species, or not? It should also be said that it was a long time before the question of their identity assumed a definite form.

At the commencement of the investigation I assumed that they probably were distinct, partly on more general grounds, and partly because at an early stage I found several *Bacilli* and *Bacteria* in the separation cultures, which proved to be quite distinct organisms. Hence, in the natural state of affairs, at any rate, there are several Schizomycetes to be looked for in the fermentations.

When examining a specimen of the Ginger-beer plant directly, in water or glycerine, for example, it is by no means obvious that the convoluted masses which form the gelatinous matrix, as it were, are Schizomycetes at all—nay, in many cases, it is not even obvious that they are organisms of any kind, and instances occur where it would be difficult to decide directly that the convolutions consist of anything more than some substance resembling a gum-like or cellulose-like body, unassociated with a living being at all.

When this is the condition of affairs, it may happen that the addition of alcohol merely causes the convolutions or the separate vermiform bodies to shrivel up and become very granular, as seen in Plate 13, fig. 5, A, B. Isolated specimens remain for days unaltered in the nutritive solutions, and I have kept them several times for periods ranging from five to seventeen days in a hanging drop. Water causes no apparent change in them; freshly-prepared ammoniacal cupric sulphate, which rapidly dissolved cotton-wool when dried, did no more than faintly tinge them blue after being in contact all night; and the other cellulose reactions failed similarly. All I could make out was that strong sulphuric acid dissolved the masses in question.

Of course, these somewhat violent procedures enable one to judge whether the

* I use the term simply in contra-distinction to sheathed; of course each has its proper cell-wall.

masses in question enclose any other bodies, and the iodine test particularly convinces the observer that, in the state I am referring to, the convoluted masses contain nothing in the nature of a filament, rodlet, coccus, or spore of any kind; they are masses of dead substance. I have found no dye stain them satisfactorily.

In the other condition of the specimens, however, the microscope at once shows the presence of the brilliant rodlets or filaments, straight, curved, or even coiled into corkscrew-like forms of numerous turns; and the above-named reagents place beyond all doubt the fact that the convoluted or vermiform masses of gelatinous matrix are the swollen sheaths of the long or short rodlets and filaments just referred to.

This point established of course led to the conclusion that we have to do with a form of Schizomycete with remarkably pronounced sheaths, and the facts observed suggest that at certain stages, or under certain conditions, the sheaths may be found devoid of the Schizomycete, either owing to the death and disintegration of the protoplasm and cells proper, or—an idea that arises subsequently—because the living schizomycetous rods, &c., escape from the sheaths.

As a matter of fact, I was led to the second conclusion, quite naturally, from the results of the cultures which established the existence of the dead sheaths.

Over and over again it was observed that, when minute pieces of the Ginger-beer plant, as a whole, were employed for infecting the sterilised media—whether solid or liquid, in tubes or flasks—the course of events was almost invariably the same, namely, as follows:—During the first forty-eight hours or so the yeast multiplied rapidly, and soon rendered the liquid media turbid; and then fermentation came to a head, and soon ceased—the yeasts falling to the bottom, or, in cases where the *Mycoderma* was favoured, forming a thick film on the top. On looking for the sheathed Schizomycete in such cases, it was rarely to be found, unless certain ordinary-looking free bacilli could be taken for it. This was, of course, the question; and experience soon showed that it would not do to conclude off-hand that the free bacilli among the yeasts were simply the Schizomycete in question, because, on separating the latter and cultivating them apart, in all kinds of media, at high or low temperatures, in tubes, flasks, or in cells under the microscope, it turned out that three forms at least were obtainable, and in some cases more, and none of these obviously resembled the sheathed and convoluted form commenced with.

The only fact really established, so far, was that the vermiform sheathed bacillus was not easily capable of direct cultivation in the form met with in the Ginger-beer plant: a fair inference was that it probably escaped from its sheaths in the cultures and then carried on its life as a non-sheathed Schizomycete, and that some one or other of the various forms found in the yeast deposits was the one in question.

The methods employed for separation were the same as those already described as being used to obtain the pure yeast-cultures, only the task was, of course, more difficult, and attempts were made to bring the gelatine media more into use.

I also employed the following method, based on the observation that when the

sheathed Schizomycete in question is at its fullest activity in the ginger-beer bottles, the sheaths are so thick and look so dense that they may possibly protect the protoplasm of the cells proper against the action of high temperatures, more than the cell-walls of the yeast-cells can protect their contents. I therefore raised the temperature of a flask of water, containing several lumps of the "Ginger-beer Plant," to 100° C. for one minute, and then allowed all to cool. This killed both the yeasts and the Schizomycete, as subsequent infections in all kinds of media at 15° C., 25° C., and 30° C., for periods varying from a week to a year sufficiently demonstrated.

I then exposed similarly washed specimens in water to 80° C. for ten minutes, also with negative results.

Exposures to 70° C. and 60° C. also give no satisfactory results; it was found that short exposures (five to ten minutes) at the latter temperature killed neither yeast nor Schizomycete, and so I abandoned this mode of attempt to separate the organisms. Evidently the death temperatures do not differ sufficiently for success.

The next method employed was that of isolation on gelatine. The mere culture of small quantities of the Ginger-beer plant itself in gelatine tubes gave the most distracting results, to illustrate which I may quote the following as an example. On December 19, I placed a minute piece of the "plant" in each of twelve thoroughly sterilised gelatine tubes, and kept the cultures at 25° to 28° C. in the incubator, with the following results.

Eight of the tubes developed yeasts in and on the gelatine which was not liquefied, and very few Schizomycetes could be found among these; those that were found had broken up into minute cocci or rodlets. I inferred that either the latter were suppressed by the copious development of the yeast, or they are of a kind which does not flourish in gelatine, and further experiments proved that the second conclusion was correct.

The other four tubes, however, had their gelatine liquefied, and the yeast entirely suppressed by a bacillus which rapidly passed through all its phases of long filaments, breaking up into typical swarming bacilli, which aggregated at the surface and produced spores in their interior.

The question, of course, arose: Are these bacilli and spores those of the Ginger-beer plant, Schizomycete? In other words, are they the free forms, which have escaped from the sheaths, and thus behave so differently?

Culture after culture proved that it was no use looking for the convoluted sheathed forms to multiply as such on or in the usual gelatine media in such tubes, under ordinary conditions; the repeated observation that just such free spore-forming bacilli commonly appeared in those tubes which did not more especially favour the yeasts, bore in the suspicion, almost amounting to conviction, that these free forms belong to the life-cycle of the Schizomycete in question. Moreover, even in those cases where the yeasts gained the upper hand, the older cultures showed swarms of bacilli, exactly like those referred to among the sedimentary cells; but the puzzling

question arose, how is it these free forms do not eventually become sheathed, and grow into the convoluted gelatinous masses of the Ginger-beer plant? And since they refused to do this even in cultures three and four months old, and more, I was again inclined to suspect that after all they had nothing to do with the Schizomycete I was hunting for.

On the other hand, evidence was gradually forthcoming, of which the following is one sample selected from many others. On December 19, 1890, small pieces of the Ginger-beer plant were placed in flasks of glucose-Pasteur. Copious fermentation and multiplication of the yeasts ensued, and a thick deposit was formed, but no typical Ginger-beer plant had developed in these flasks up to the end of January, 1891; the deposit consisted entirely of yeasts and free bacillus-like rods.

On December 28, 1890, I placed a drop of the still recognisable Ginger-beer plant from one of the above flasks, into a tube* of ginger-gelatine; and here again free bacillus-like rods and yeasts alone were recognisable after a few days, and up to February 28, 1891, this culture showed no typical "Ginger-Beer Plant;" simply free bacillus-like rods among the thickly deposited yeast-cells at the bottom of the liquefied gelatine.

Meanwhile, on January 26, I infected a tube of ginger-gelatine, mixed with an equal quantity of PETER'S gelatine, with the mixed yeasts and rodlets of the last culture. Things went on much as before, and up to February 28, 1891, no "Ginger-beer plant" was developed, though the yeasts and rodlets were very abundant and healthy in appearance. It should be noted that throughout these cultivations the free rodlets were of one predominant species, as I carefully convinced myself after each transfer, and by comparing their behaviour.

On February 1, 1891, I again infected a tube of equal parts HAYDUCK'S gelatine-ginger and PETER'S gelatine with the rodlets and yeasts from the last culture. Up to February 9 things went on as before, and I had no reason to anticipate any greater success than in previous experiments; the copious deposit at the bottom of the tube consisted of yeast-cells with crowds of intermingled rodlets. But on the 28th February the tube contained abundance of the typical Ginger-beer plant, *i.e.*, convoluted sheathed rods and filaments entangling the yeast-cells in the gelatinous mass.

Of course this did not *prove* that the free rodlets gave rise to the sheathed filaments, but, as I have said, it was only one case out of many others which went to show that, under certain conditions I could only find free rodlets among the yeast-cells, whereas under other conditions I found the sheathed and gelatinous forms. My methods, and control experiments, convinced me that there was here no case of casual infection from outside, and one of two explanations only could be entertained.

Either some free rod-like Schizomycete became a dominant form, and suppressed

* In all such cases as this, I employed at least one, and generally two, check-tubes, all side by side.

the true "Ginger-beer" Schizomycete; or, the latter organism does really lose its sheaths, and live and multiply as a free moving bacillus-like form, until certain changes in the environment compel it once more to assume the sheathed state.

The latter seemed the more likely alternative, because the very fact of the successful cultures containing so many of the free rodlets during the early stages would seem to disprove the former; nevertheless, of course it does not do to lay too much stress on such evidence where bacteria are concerned.

Such was the state of affairs at which I took up the re-investigation of the particular form referred to.

A considerable step forward was made in December, 1890, when I found the case recorded in fig. 7, Plate 13. Specimens of both yeasts and rodlets of a clean culture of the Ginger-beer plant were growing together in a hanging-drop of ginger-gelatine. My attention at the time was being more particularly directed to the yeast. After two days, however, it became evident that the rodlets among the yeasts were changing, and so I watched a slightly coiled sheathed one marked α in fig. 7. The results are evident from the drawings. At 9 A.M. on December 31, the first note was made and the specimen drawn; at 3 P.M. on the same date, the filament had evidently elongated considerably, together with its investing envelope or sheath, as seen at b . The growth was yet more pronounced at 9 P.M. on that day, as shown at c , and a comparison of the drawings shows that the growth was chiefly at the right-hand end of the filament, though intercalary elongation also occurred. d exhibits the state of affairs next morning (January 1, 1891) at 11 o'clock; e was drawn at 3 P.M., and f at 9 P.M. on the same date. Next day (January 2) the stage g was reached at 10.30 A.M., but the growth now slowed off considerably, for the curious stage h was not reached until 11 A.M. on January 3, and it is evident that little more than a contortion or screwing up of the coils had occurred. No more changes were observed, although the specimen was carefully watched till January 9, and I thought it probable that the low temperature accounted for the cessation of activity.

Having once satisfied myself of the above phenomena, which, moreover, explained some previous imperfect observations in trapped gelatine cultures, an obvious inference was drawn, namely, that the growth of these filaments only begins after the yeast-cells have exhausted the oxygen of the culture-drop and its surrounding atmosphere. A careful revision of all my previous notes and tube- and flask-cultures bore out this suggestion, and it was really only a confirmation of what I had suspected from the behaviour of the Ginger-beer plant in the fermentations in soda-water bottles; for, as pointed out previously, the first thing observed is a copious shedding and multiplication of the yeast-cells; the increase of the plant as a whole is not observed until later. Obviously these yeast cells will have used up all the free oxygen by that time.

Indeed this latter statement does not depend on mere inference from what we know of the general life-history of the yeasts, for in the fermentation-cultures in soda-water

bottles connected with manometer tubes (described on p. 137) the first thing was always a rise of the mercury in the proximal leg of the U-tube, obviously due to the vigorous absorption of the oxygen of the air by the yeasts, because, in the first place, it only occurred when the culture was made in air, and, in the second place the diminution of volume—*i.e.*, the volume of gas absorbed—was in agreement with our knowledge that nearly one-fifth of the air, by volume, consists of oxygen.

I had meanwhile attempted over and over again to isolate the Schizomycete, and examine its properties in pure cultures, and at last succeeded in doing this.

It seems now almost ridiculous that I should have failed so long in obtaining satisfactory pure cultures; but, although it is easy enough to separate the Schizomycete now, when I know something of its vagaries, the difficulties were natural so long as I looked only for the sheathed and gelatinous form. As a matter of fact, I had isolated the organism long before this, but it was then regarded—at any rate provisionally—as a separate species, to be worked out as time and opportunity admitted.

Be this as it may, the first time I thoroughly satisfied myself that my tubes contained the Schizomycete was on February 27, 1890, when I found that a culture in HAYDUCK'S solution presented the following appearances. The liquid in the upper two-thirds of the tube was clear, but a sort of cushion of jelly-like substance had formed at the bottom of the tube. This cushion proved to be composed of dense coils and masses of the typical sheathed Schizomycete I was seeking for.

The history of this culture was as follows. On the 9th of the previous December, I had placed a lump of the Ginger-beer plant, carefully washed in pure water, into a flask of glucose-Pasteur's solution. The usual fermentation followed, and a number of separation cultures were made on the third day, into tubes of gelatine-glucose. Two days later re-infections were made from these tubes into new tubes of the same medium; and one of these tubes, after incubation for three days, was used for further infections.

On the 9th January, the predominating organism in a selected tube of this series of transfer- or dilution-cultures, was found to be a bacillus-like body, flourishing among the few suppressed yeast-cells which also occurred in the tube.

A drop, as small as possible, of the sediment containing the "bacilli," was now (January 9) transferred to tubes and flasks of HAYDUCK'S gelatine-glucose, and on February 14 a tube of HAYDUCK'S solution was infected from one of the above tubes.

Further cultivation showed that the yeast had now become eliminated, or suppressed entirely, and on February 27, as said, there was a cushion-like, gelatinous deposit, composed of the sheathed rodlets and filaments in question. This tube afterwards became very useful, and supplied me with material for successive re-infections, leading to the absolutely pure cultures obtained subsequently.

It should be borne in mind that I did not certainly know that this cushion consisted solely of the form in question, the only conclusions I drew were, first, that

the vermiform sheathed organism sought for could be grown in the medium (HAY-DUCK'S solution) mentioned, and, secondly, that it could be developed apart from the yeast.

Having now obtained the long-sought organism—the sheathed Schizomycete—separate from other forms, it promised to be a comparatively easy task to cultivate it pure in hanging drops under the microscope ; but this proved to be by no means so simple as I supposed.

After numerous failures, due in part to the unsuitable media, and in part to the sensitiveness of the organism to transference from tube-cultures to the hanging drops, I arrived at results by the use of beet-gelatine and of bouillon-Pasteur-gelatine. Difficulties arose from the facts that the sheathed organism will not readily grow as such in gelatine, and that it was necessary to employ as little as possible of this medium—only just as much as would suffice to slightly fix the specimens. I used about 1–2 per cent., according to the temperature. The next obstacle was the frequent refusal of the Schizomycete to grow at all, in its sheathed form, in the stiffened media.

At length I obtained some very puzzling results, shown in figs. 1–4, Plate 14. When first observed, I supposed that this was a pathological phenomenon ; but it has now been followed so often and so closely, that my explanation of it may probably be accepted as the true one.

In the cases referred to, the rod-like Schizomycete either escapes altogether from its gelatinous investment (fig. 2, Plate 14) ; or, more frequently, it does so partially only, and goes on adding to the sheath as it travels forward (*see* figs. 1 and 4, Plate 14).

This process of partial or total emergence of the Schizomycete proper, from its gelatinous investment, is not only a curious fact in itself, but it is connected so closely with the conditions of the environment, that it may be taken as an indication on the part of the organism that some change has occurred in the surroundings.

This may be fairly concluded from the observations that so long as the conditions in the hanging-drop are favourable, the organism remains in the sheath, and grows symmetrically in it ; moreover, it does this very generally in the fermentations carried on in soda-water flasks, whereas any interference with the medium induces the unequal growth just referred to.

I found that if I simply transfer a drop from such a fermentation to a cover-slip, and use it as a hanging-drop, the sheathed organisms behave as above described—the rodlets, &c., merely escape from the sheaths, and become isolated, naked filaments, rodlets, &c., according to their length at the time.

If, however, I transfer such a drop carefully into a hanging-drop of suitable food materials, some of the specimens at least do not thus cast their sheaths forthwith, but they behave in most cases, as in the one figured at Plate 14, figs. 1 and 4.

The rodlet travels forward (fig. 1), or sideways (fig. 4), and goes on continually

forming more and more of the sheath substance in its wake, as it were ; and although it keeps ahead, and even appears to be projecting free from this sheath substance, one can see that the latter really invests it all round, only it is thin at the forward end.

The most curious paths are described by the onward growing organism, as recorded by the curves, bends, coils, &c., of the sheath substance (see Plate 14, figs. 1, α - g), but the most remarkable thing about the whole phenomenon is that in many cases the rodlet does not perceptibly elongate or enlarge during the process : it simply goes forward—end on or side on—as it were, like an erratic rocket leaving a tail behind it.

The above phenomena amply explain the meaning of my earlier observations of some of the forms found in the fermentations, as shown in figs. 3 to 6, and 8 Plate 13). The empty sheaths (figs. 3-5), and the sheaths with eccentric or apparently protruding filaments, rodlets, &c. (fig. 8), became intelligible at once in the light of the above cultures.

It now remains to see what information is forthcoming as to the conditions which determine the escape of the organism from its gelatinous investment.

The presence of oxygen—*i.e.*, air containing that gas—seems to cause the phenomenon at once, for I have observed over and over again that when the sheathed organisms are transferred from a strong fermentation (in which it may be assumed that no trace of free oxygen exists) to a newly-made hanging drop of the same medium as that employed for the fermentation, the rodlets at once proceed to free themselves of the sheathing substance. If there are yeast-cells present in the drop, however, the sheaths are soon developed again, presumably because the *Saccharomycete* rapidly uses up all the oxygen.

This is quite in accordance with all I have been able to find out as to the development of the Ginger-beer plant as a whole. It is not found in open vessels, or even in tubes and flasks plugged with cotton wool, so long as any free oxygen is present ; whereas it develops rapidly enough (in suitable nutritive solution) if a film of *Mycoderma* or mould forms at the top, or when the yeast has used up all the oxygen, or if the cultures are placed in the receiver of the air-pump, and the air thoroughly replaced by carbon dioxide.

Moreover, I have satisfied myself of this by means of duplicate cultures in hanging drops of the same nutritive medium—one in carbon dioxide being carried on side by side with one in air—in the gas-chamber described on p. 131. In no case have I been able to make the organism develop its sheathing jelly in an atmosphere containing oxygen ; but in a constant atmosphere of carbon dioxide it does this readily, provided the nutritive medium is suitable in other respects.

Similar comparative cultures show that the nutritive medium must contain carbohydrates. The Schizomycete lives and grows in bouillon alone, and in other media devoid of carbo-hydrates, and I shall have something to say of its behaviour in such solutions presently ; but it does not develop the sheathing substance in them.

Of the carbo-hydrates I have employed, ordinary cane-sugar seems to be more suit-

able than glucose. Milk-sugar is of no use. This is a point of interest, because there were certain grounds* for believing that the Ginger-beer plant would possibly do well in milk-sugar; such is not the case, however.

On comparing the cultures in PASTEUR'S solution made with the various sugars—cane-sugar, glucose, and milk-sugar—it comes out very clearly that, although development does occur in the first and second, the growth is very unsatisfactory unless either asparagin or, better, bouillon is added. But even such solutions as Pasteur-bouillon are rendered much more suitable for the development of the Schizomycete if a little ginger is added. This was for a long time a puzzle to me. Experiments showed that the ginger might be sterilised, if care is used, and my usual method is to expose finely-sifted crushed ginger, in a stoppered bottle, to 90° C. for a couple of hours on several successive days. This slightly browns the ginger, but does not destroy its pungency, though some of the oil is probably driven off.

It was difficult to believe that the essential oil,† a hydro-carbon, could be utilised by the Schizomycete, and investigation showed that the reservoirs of oil in the ginger rhizome are untouched by the organism. The alternative was to suppose that the starch in the cells was the useful adjunct, and this seems to be the case, for I have obtained very good results by substituting sterilised ground rice for the ginger.

Another condition for the development of the gelatinous sheaths is that the medium shall be acid. In such solutions as those of HAYDUCK, PASTEUR, &c., this is effected by the di-hydric phosphate, and when the yeast is present the carbonic acid aids matters. I have not made any special experiments as to what acids will or will not do, but no doubt tartaric, citric, malic, and other vegetable acids would be found to be suitable.

For a long time I was driven to believe that the presence of the yeast was essential for the growth of the sheathed Schizomycete. Although this is certainly not the case (because the pure cultures disprove it), it is, nevertheless, very remarkable how much better the organism develops, in some of the media, in presence of the yeast than apart from it, and one is impelled to the suspicion that some product of the yeast's action on the saccharine solution is made use of by the Schizomycete.

I tried to test this by means of the following apparatus (fig. 4):—

A tall museum jar of glass (*a*), has its edge ground flat, so that the strong perforated glass plate (*c*) may be fitted to it, and rendered gas-tight by the compressed caoutchouc ring (*b*). Into this plate is fitted the manometer tube *dd'*, with mercury. The glass jar (*a*) is about two-thirds filled with the solution to be employed, *e.g.*, Pasteur-bouillon.

Easily standing inside the jar *a* is a Chamberland filter-tube (*e*) of unglazed porce-

* Based on the resemblances which it presents to the "Kephir-grains" of the Caucasian milk-ferment (see p. 187, footnote).

† See HUSEMANN, 'Die Pflanzenstoffe,' vol. 1, p. 423.

lain, the glazed nipple (*g*) of which is closed by a piece of glass rod (*f*) held by well-fitted caoutchouc-tubing.

Fig. 4.

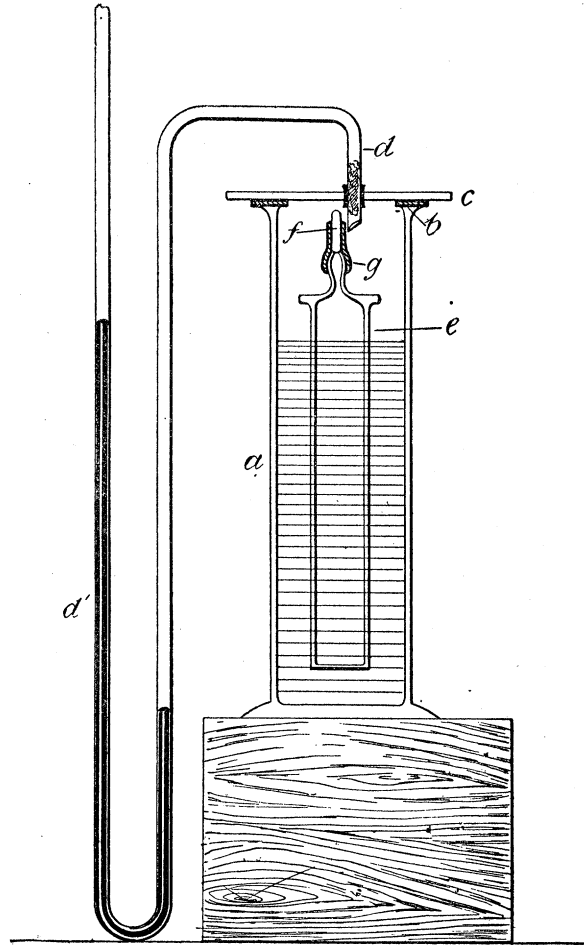

Apparatus for the simultaneous growth of the yeast and the Schizomycete, in the same medium, but separated by a porcelain film; *a*, glass cylinder partly filled with the culture-medium; *e*, Chamberland filter of unglazed porcelain, and also filled to the same level as *a* with the same medium. The liquid in and outside *e* is continuous through the porous porcelain, but the organisms cannot pass; *b*, caoutchouc ring; *c*, glass-plate; *dd'* manometer-tube plugged with cotton wool where the proximal end is jammed into the plate; *f*, a stopper fitted into *g*, a piece of caoutchouc tubing. All sterilised before infection; in semi-diagrammatic section and reduced.

The glass plate (*c*) is held down by double cords passing over the plate and below the base of the jar, and twisted (after the fashion of a tourniquet) by means of wooden pegs. This is quite effective, as proved by the apparatus being gas-tight even under high pressure.

All the glass parts are sterilised at 150° to 180° C. for several hours, and the caoutchouc parts by steeping in corrosive sublimate for several days, then in absolute alcohol, and finally washed and boiled in sterilised water for an hour. After charging

the jar with the previously sterilised nutritive fluid, the Chamberland tube is placed in it, and the whole sterilised at 80° C. for an hour on two successive days.

When finally cooled and ready, a few drops of the yeast (*Saccharomyces pyriformis*) from a pure culture were put into the Chamberland tube, into which a certain portion of the nutritive fluid had diffused through the porous porcelain sides; this tube was then stopped, by the glass rod *f*, in order to prevent any yeast from escaping to the exterior through the nipple *g*. I proved clearly, by several experiments, that neither the Schizomycete nor the yeast-cells can pass through the pores of this tube.

Then a trace of the Schizomycete (*Bacterium vermiforme*) was put into the liquor in the outer tube, and the whole apparatus closed by the glass plate (*e*) with its attached manometer, *dd'*, the short arm of which was plugged with sterile cotton-wool.

The course of events in this apparatus was always the same, provided the nutritive solution was a suitable one. At first a distinct absorption of gas was noticeable, as indicated by the rise of mercury in the proximal leg of the manometer. This usually lasted for about twelve to twenty-four hours, and was obviously due to the absorption of the oxygen by the yeast in the porcelain tube.

Then sets in a period during which the level of the liquid in the glass jar (*a*) rises; this is due to the pressure of the carbon dioxide, now being evolved by the ferment activity of the yeast increasing in the inner tube (*e*), and driving the liquid through the pores out into the jar (*a*). At the same time the mercury in the distal leg of the manometer begins to rise, and continues to do so in proportion as the pressure of the gas increases.

As the pressure of carbon dioxide increases, the level of the liquid becomes gradually equalised in both tubes, and it may be assumed, that while neither the Schizomycete nor the yeast-cells can come in actual contact (because they cannot traverse the porous porcelain), any soluble ingredients due to the fermentative action of either can pass and mingle in both tubes.

By this means I first proved conclusively that the Schizomycete can carry on its normal life-actions separately from the yeast, and in the course of a few weeks the whole of the liquid in the tube *a*, which was outside the porous tube (*e*), was filled with cloudy clots of gelatinous masses, which were simply aggregations of the sheathed bacterium already described, and named *Bacterium vermiforme*. Then the whole mass becomes a semi-solid jelly, consisting almost entirely of the coiled, sheathed Schizomycete.

My next departure dates from a discovery made when examining a tube of bouillon which had been carefully prepared, and belonged to a very successful and satisfactory series of cultures. This particular tube* had been in an atmosphere of hydrogen for seven days. It was found that the turbid liquid (bouillon) was teeming with actively

* It should be noted here, again, that I select *one* tube only for definite descriptions, though, as in all cases, my conclusions are derived from the results of several parallel cultures which agree.

swarming rodlets, some so short as to be almost cocci, others several times longer than broad, others again united into long filaments.

As already said, the tube was one of a series that had been very carefully prepared, and in which I had great confidence, and examination showed that none of its uninfected fellows were turbid, while all the rest of the series—some in air at 15° C., others at 25° C., others in carbon dioxide—were similarly teeming with the swarming bacteria, after different periods in each case. It was certain, therefore, that the swarmers had developed from the organisms with which the tubes were infected, and not from bad sterilisation or from the outside.

The following is the history of the tube in question. It had been sterilised by discontinuous heating on four successive days, and was perfectly clear when put with its fellows under the air-pump, after being infected. The receiver (see fig. 5) was

Fig. 5.

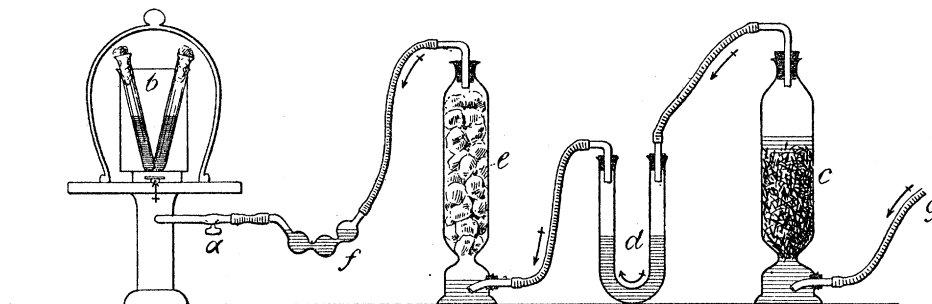

Arrangement of apparatus for growing cultures in hydrogen (or carbon dioxide if necessary). *a*, stop-cock of air-pump, under the receiver of which are the plugged tube-cultures, *b*; *c*, hydrogen generator; *d*, U-tube with AgNO_3 ; *e*, pumice saturated with KHO ; *f*, pyrogallic acid solution to rid of traces of oxygen; *g*, pipe conveying dilute sulphuric acid (*cf.* fig. 2, p. 132). Semi-diagrammatic section, reduced.

then exhausted as thoroughly as possible, and hydrogen passed in; after twenty-four hours the processes of exhaustion and refilling were repeated, and the receiver tied down with a tourniquet, and the gas forced in under a pressure equal to about 3 inches of mercury. The apparatus for this and similar gas culture is sufficiently explained by fig. 5. All was then left at 15° to 16° C. for seven days.

The infecting material was the same in all the tubes referred to, and had come from a source whose rather curious history was duly chronicled, and is as follows:—Pieces of Ginger-beer plant, thoroughly washed in distilled water, were put into a flask of PASTEUR'S solution, made up with glucose. In three days the turbid liquid contained abundance of mixed yeasts and bacteria, and tube-cultures were prepared. Next day re-infections were made into fresh tubes, and so on till the yeast was gradually eliminated.

From these final separation cultures, which showed only the bacterial rodlets, new

infections were made into HAYDUCK'S solution, and in fourteen days the bottom of these cultures contained the clots of gelatinous sheathed bacteria now so well known.

From one of these last tubes I made a large number of comparative cultures, and there was no question as to the isolated bacterium being the right one. One of these cultures was now employed. It was a tube of gelatine-ginger solution, infected on February 28th with a minute trace of the gelatinous cushion at the base of the tubes referred to. At first clear, the liquid went through various stages of turbidity, and ended by itself forming a similar gelatinous cushion at the base of the tube, and on March 30th this cushion was quite normal, as in all the other tubes of the series.

On March 8th, a culture in HAYDUCK'S solution of the above was made: this progressed normally and yielded the gelatinous bacterial masses in such abundance that the tube could be upturned—the whole of the contents were transformed to a stiff jelly of sheaths enclosing the bacteria.

From this tube, of the pure sheathed form, cultures were made *in vacuo* (in the apparatus, fig. 6, described on pp. 170 and 171), in which no gelatinous form appeared—only free filaments, rodlets, and cocci (see Plate 14, figs. 6 and 7).

Some of these free forms, after one month in the vacuum apparatus, were then employed to infect a series of tubes of HAYDUCK'S gelatine, and again the gelatinous form was eventually obtained.

It is impossible to give even a *résumé* of all the series between this last one and the one started with. It must suffice to say that I satisfied myself at every stage that the cultures were true throughout, and that, in all cases where the conditions given on pp. 158 and 159 were fulfilled, the gelatinous sheathed bacteria were at length developed; but where, as in the vacuum experiments referred to, the conditions were altered in certain directions, the sheaths were not formed, and only the free filaments, rodlets, and cocci were developed.

I now return to the tube of bouillon, in hydrogen, referred to on p. 162. It had been infected, as one of a large series, with the gelatinous sheathed bacteria of a certain tube whose history has been described, and, as said, after seven days in the hydrogen, the whole of the bouillon was uniformly turbid with swarmers—rodlets, cocci, and filaments.

The filaments measured from $10\ \mu$ to $50\ \mu$ and more in length; the rodlets from $1\ \mu$ to $5\ \mu$; and the cocci were about $0.5\ \mu$ in diameter, which is also the average diameter of the rodlets and filaments.

Microscopic cultures in hanging drops showed that the rodlets and the filaments alike break up. The rodlets into smaller rodlets, and these into cocci; the filaments into shorter and shorter rodlets and cocci (see Plate 14, figs. 6 and 7). But while this is the final fate of them all in the bouillon, there is an intermediate stage when the shorter rodlets are actively motile, and dividing with greater or less rapidity.

In drops of bouillon-gelatine with a little sugar added I was able to follow the (retarded) division of these motile rodlets (Plate 14, fig. 7). Each rodlet simply

elongates, constricts, and divides in the middle, and each half repeats the process. This goes on several times until at last the short rodlets halve into two cocci (Plate 14, fig. 6, *f*), which remain unaltered in the medium.

I made numerous attempts to demonstrate the existence of flagella on these motile forms, not only by staining with hæmatoxylin, but also by the following more complex method, which is said to be very good in many cases.* The culture in bouillon is diluted with pure water, and a drop of the fluid placed on a cover-slip; then a drop of 10 per cent. alcohol is added, and the whole placed to dry at 40° C.

When dry the residue is stained with the following mixture:—20 parts of a 10 per cent. tannin solution, 5 parts ferrous sulphate, 1 part methyl-violet, made up to 100 parts with water, and used either just acid or alkaline.

However, in no case could I determine the presence of flagella, either on the rodlets or the cocci. This leaves us in the dark as to whether such motile organs exist: the same is true for other active forms, in which, as here, the movements are so vigorous that it is natural to look for cilia as producing them.

In all the media which, like bouillon, induce the development of these motile forms only, the succession of events seems to be the same. The long naked filaments break up into shorter and shorter dividing rodlets, which eventually break up into cocci (Plate 14, figs. 6, 7, and 8); and although I have cultivated these forms for many weeks in hanging-drops, no other result has been obtained.

Having got thus far, and having satisfied myself of the existence of two distinct phases of this organism—the vermiform sheathed stage found in acid saccharine media saturated with carbon dioxide, as contrasted with the motile naked filaments, rodlets and cocci met with in neutral bouillon and other incomplete nutritive media—it was necessary to take the precaution of cultivating both forms side by side, under exactly similar conditions, varied one by one similarly for each.

Before describing the experiments to this end, however, it is necessary to say a little more about the macroscopic appearances presented in tube-cultures of this Schizomycete.

When a small piece of the gelatinous form—*i.e.*, the compacted coils of sheathed filaments, rodlets, &c.,—of *B. vermiforme* is put into a test-tube of suitable nutritive fluid (*e.g.*, Pasteur-bouillon, beet solution, bouillon + 5 per cent. of sugar, &c.) and kept at 15° to 18° C., the usual course of events is as follows:—

The liquid becomes more and more turbid after 48 hours or so: then a whitish film begins to form above, and a deposit at the edges of the level of the liquid, while a similarly whitish, granular or cloudy looking deposit falls to the bottom. In from 7 to 14 days the rapidly increasing deposit becomes more and more gelatinous, and at length assumes the consistency of a sort of jelly. This gelatinous cushion at the base consists of the sheathed coils so often referred to; the film and ring at the level of the

* *E.g.*, by WOODHEAD, 'Bacteria and their Products,' 1891, p. 413.

liquid, and the turbidity throughout the body of the same, are chiefly due to the free filaments and rodlets already described as escaping from the sheaths. In the early stages of the enquiry I missed the point that the preliminary turbidity of the liquid is due to the motile forms of these filaments and rodlets, but on further looking into the matter such turns out to be the case. Only two explanations of this seem possible, namely, either (1) the preliminary turbidity of the liquid by motile rodlets, and the film of filaments and rodlets at the top, are caused by the escape of members of *Bacterium vermiforme* from their sheaths, and these free forms then grow out into filaments which break up into motile rodlets, and so occupy the upper parts of the liquid; or (2) the only alternative is that some foreign form is mingled with the gelatinous sheathed organism, and the turbidity, film, &c., are due to the rapid spread and divisions of its members.

The arguments in favour of the *first* of these alternatives are so far conclusive against the *second*, and I shall put them in order here to enable the reader to see clearly how the matter stood up to this stage in the investigation. Of course, the possibility of the admixture of two organisms could not be denied, however carefully my cultures were made, in view of the admitted impurity of the usual supplies of Ginger-beer plant, from which I started in the first instance; moreover, since I had to separate the Schizomycete by the methods of dilution, because it will not flourish on gelatine, and hence KOCH'S method was inadmissible, there was always present in my mind in the early period of investigation the doubt lest I had carried over with the desired organisms traces of some form as yet unknown.

On the other hand, it was not unnatural that I should suspect the gelatinous form to be a sort of so-called zoogloea stage of my Schizomycete, and, in that case, the existence of a free stage, probably motile, was to be expected from what we know of other forms.

My suspicion that the above-described free and motile form really belongs to *B. vermiforme*, was strengthened by the constant recurrence of the phases (preliminary turbidity, film, and flocculent deposit) above referred to in all the cultures.* It was further strengthened by the discovery (see pp. 157 and 158) that the rodlets certainly do escape from their sheaths when put into a fresh supply of nutritive liquid containing oxygen; as well as by the apparent identity in size, shape, and other characters of the free forms in both cases.

It was further strengthened by the future behaviour of the tubes in which, after the preliminary turbidity, &c., the formation of the gelatinous cushion, composed of the typical coiled and sheathed forms, was completed at the base of the tubes. Over and over again—that is to say, scores of times—I found that if these tubes were kept for periods varying from about three to six weeks (depending on the nutritive medium, the atmosphere, and the temperature, and of which more will be said

* The actual number of such individual cultures amounted to over three hundred.

presently), the contents became uniformly stiff throughout. The whole of the contents were transformed into a yellowish, translucent, stiff jelly, of sheaths in which the bacteria were evenly distributed and firmly embedded.

It now remains to describe a comparative series of tube cultures made during the long vacation to decide the above question—Are the motile rodlets, &c., alone found in certain media (*e.g.*, bouillon), identical with the typical sheathed bacterium met with in the saccharine media (*e.g.*, bouillon-Pasteur) saturated with carbon dioxide? Sixty tubes were prepared, and divided into two series of thirty each; one series was infected from the stiff gelatinous mass composed of the sheathed form of our bacterium, the other was infected with the free motile rodlets obtained in a bouillon culture.

In each series of thirty, there were six groups of five tubes each. For the sake of clearness I may classify them as follows:—

Series No. 1. Thirty tubes, infected with gelatinous form, comprising—

Five tubes charged with bouillon and labelled A, B, C, D, E.

Five tubes charged with bouillon-glucose and labelled F, G, H, I, J.

Five tubes charged with bouillon-sugar and labelled K, L, M, N, O.

Five tubes charged with bouillon-Pasteur and labelled P, Q, R, S, T.

Five tubes charged with plum-decoction and labelled U, V, W, X, Y.

Five tubes charged with dilute ginger-solution and labelled AA, BB, CC, DD, EE.

Series No. 2. Thirty tubes, infected with the motile form, comprising—

Five tubes charged with bouillon and labelled I., II., III., IV., V.

Five tubes charged with bouillon-glucose and labelled VI., VII., VIII., IX., X.

Five tubes charged with bouillon-sugar and labelled XI., XII., XIII., XIV., XV.

Five tubes charged with bouillon-Pasteur and labelled XVI., XVII., XVIII., XIX., XX.

Five tubes charged with plum-decoction and labelled XXI., XXII., XXIII., XXIV., XXV.

Five tubes charged with dilute ginger-solution and labelled XXVI., XXVII., XXVIII., XXIX., XXX.

The first tube of each group of five (*i.e.*, tubes A, F, K, P, U, AA, and tubes I., VI., XI., XVI., XXI., and XXVI.) was then put into a strong glass vessel, which was first securely closed, and fitted to a good air-pump.* Having exhausted it of air as thoroughly as possible, carbon dioxide was passed in to saturation; the exhaustion was then repeated, and again pure carbon dioxide passed in till a slight pressure was obtained. The exhaustion and refilling with pure carbon dioxide gas were repeated next day, and then the vessel was finally closed and put aside at 15° C.

* Apparatus described and figured at fig. 5, p. 162.

The second tube of each group of five (*i.e.*, tubes B, G, L, Q, V, and II, VII, XII, XVII, XXII, and XXVII.) was treated in exactly the same way, so far as exhausting went, but was kept in the receiver over the air-pump and filled under slight pressure with hydrogen, purified by passing through silver nitrate, potassium hydrate, and pyrogallic acid. (Fig. 5, p. 162.)

The third tube of each group of five was kept in air in the incubator, maintained at 25° C. throughout.

And the fourth and fifth tubes of each group of five were kept in air at 15° C.

The cultures were left undisturbed for a week, and then examined; they were then replaced and not re-examined until fourteen days had passed; again at the end of the third week; and then the tubes in carbon dioxide and those in hydrogen had to be removed, and air would generally find access to them. The further examinations need not be detailed, as all the information I wanted was forthcoming before they occurred.*

It will be understood that the detailed examination and reporting upon such a series occupied some time. It was necessary to compare all the duplicate sets, and to examine samples of the contents of some tubes with the microscope; when this is done, it is my practice to infect a duplicate tube at once, in case anything goes wrong with the original one in the act of rapidly removing and replacing the cotton-plug, and taking a sample on the end of a freshly drawn glass capillary. In some cases, more than one duplicate has to be made. All such events are noted, and the following conclusions were drawn from comparison of the *original* tubes only.

We may first eliminate the tubes which yielded no results. All the tubes of plum decoction remained perfectly clear throughout the whole period of experiment, *i.e.*, three months. Whether the want of acidity, or an insufficiency of nitrogenous materials, or the kind of sugar, accounts for this, I do not know; there is something to be said for the latter view, since the bacterium, curiously enough, does not do so well in glucose-solution, as in those prepared with saccharose. Be this as it may, the tubes U to Y inclusive, of Series No. 1, and the tubes XXI. to XXV. inclusive, remained perfectly clear for three months, whether in carbon dioxide, in hydrogen, or in air, at 15° C. and at 25° C. It should also be noted that both series behaved exactly alike.

In the ginger solution—fifteen parts, by weight, of preserved ginger syrup, to eighty-five of water—there was very little growth. The tubes in CO₂ remained perfectly clear for three weeks, those in hydrogen the same. The tubes in air developed very faint films, more pronounced at 25° C. than at 15° C.; but no further growths occurred even after three months. It is worth notice that the tubes put into CO₂ and then in hydrogen also started to form these rudimentary films *after being a week*

* These tubes were kept for several months longer and nothing occurred to alter the conclusions drawn at the time I regarded the experiments as ended, but, on the contrary, these conclusions were strengthened by the after events.

in air, but not so long as they were in hydrogen. But the most striking fact is that, comparing tube with tube of each series, those tubes infected with the gelatinous form behaved exactly like those infected with the free motile rodlets.

Now let us turn to the two groups, A to E inclusive, and I. to V. inclusive, the tubes of bouillon. These again behaved similarly, comparing tube with tube. In CO₂ the tubes A and I. remained clear at first, and then began to develop thin films, which precipitated white flocks to the bottom of the tubes. Nothing more happened, even after three months.

In hydrogen the tubes B and II. turned slightly turbid, and formed the precipitate during the first week. Nothing further occurred.

In air, all the other tubes became turbid, in two days at 25° C., in three days at 15° C. After fourteen days a considerable deposit was formed; this consisted of short rodlets and cocci, the turbidity was due to the minute swarming rodlets. Nothing further occurred, even after three months.

In the tubes of bouillon-glucose—5 per cent. of glucose—the growth was distinctly more pronounced in both series. In CO₂ the tubes F and VI. began by being turbid, and then formed a whitish deposit of rodlets and cocci. In hydrogen similarly, but to a less extent in both tubes. In air the tube H (at 25° C.) advanced more rapidly than the tube (also at 25° C.) VIII., and in five days had formed a large flocculent deposit and film; smaller ones were found in VIII. at the same date. The other tubes behaved quite like these, but more slowly. In all cases—except that the tube H was more advanced during the first fortnight—it was impossible to distinguish between the tubes infected with the motile rodlets and the corresponding tubes infected with the gelatinous coils.

So far, the slight development of the organism was evidently due to the nutritive fluids being incomplete. The plum decoction (somewhat to my surprise, I confess, because this medium is an admirable one for most ordinary fungi) proved the worst, and the dilute ginger-solution was but little better. The bouillon-glucose stimulated the bacteria to good growth at first, but it also was incapable of supporting large typical growths. We now come to very different phenomena.

In the tubes of bouillon-sugar (5 per cent. of brown sugar) in CO₂ the tube K became very turbid in two days, and within the week had formed a large brain-like mass of the coiled sheathed forms below; its further behaviour was as described on p. 163, resulting in the whole mass being converted into a stiff jelly; but, be it noted, the course of events in the corresponding tube XI. was *just the same*, and although the gelatinous cushion was not so large, it was quite typical. In L and XII. (in hydrogen) also the gelatinous cushion was developed during the first week, and again L was in advance of XII. by a day or two, and contained more of the free swarming rodlets on the seventh day. After six weeks both tubes had a large normal cushion below, and a film above, but the intervening liquid was not quite gelatinised throughout, even after three months.

The tubes M and XIII. (in air at 25° C.) were very interesting. Both became very turbid on the third day, and had begun to form their gelatinous cushions on the fourth day. In a fortnight the cushions were very large, occupying about a third of the liquid. In three weeks M was a stiff jelly throughout; XIII. did not solidify throughout in five weeks, though it was similar to M in all other respects. The tubes (in air at 15°) N and O behaved exactly like M, but more slowly, and were solid throughout in five weeks; XIV. and XV. both formed cushions, and were quite comparable with N and O, only they did not stiffen so much.

The tubes P to T inclusive, and XVI. to XX. inclusive, charged with bouillon-Pasteur, behaved very similarly to the last series. All that concerns us here is that the whole of the five tubes infected with the swarming rodlets developed the gelatinous cushions within the fortnight, and were stiff throughout in from three to five weeks. It remains to add that Tube XVII., designed to go into an atmosphere of hydrogen, was inadvertently placed in air at 15° C.; its behaviour was, accordingly, like that of the Tubes XIX. and XX. in every respect.

On looking over the records of these two double series of cultures, in bouillon-sugar and bouillon-Pasteur, several points of interest are noticeable, in addition to the proof much of greater nutritive value of these media.

In the first place, it is evident once more that the organism is anaërobic in a high degree; and I would call attention to the fact that the cushion—*i.e.*, the gelatinous coils—do not form until there is a large quantity of carbon dioxide in the liquids. Even in the case of the tubes charged with hydrogen, and kept in an atmosphere of that gas, the medium gradually became saturated with carbon dioxide *in those cases where a carbo-hydrate was present*—a significant fact, I think, as indicating the source of the carbon dioxide; and it is noticeable how much sooner the cushions were developed in the tubes kept (in air) at 25° C. than in those at 15° C., a fact explicable by the enhanced activity of the organism in its early stages. These tubes in air also show that, in its free stages, the organism can be aërobic, though the cultures in carbon dioxide prove that oxygen is not necessary.

I have other evidence, however, which goes to show, not only that the above conclusions are correct, but that the presence of the carbon dioxide is necessary for the proper development of the sheathed, coiled forms—*i.e.*, the gelatinous cushion.

I have already stated that this Schizomycete can be cultivated in vacuum tubes, exhausted as perfectly as possible by means of a very good mercury pump.*

During the year 1890 I made a large number of cultures in tubes of HAYDUCK'S solution, preserved ginger solution, and beet decoction, prepared as follows, and infected partly with the Ginger-beer plant, and partly with the Schizomycete only. Strong glass tubing, about half an inch internal diameter, was drawn carefully at one end and sealed at the other, and then exhausted as thoroughly as possible, and the

* Kindly placed at my disposal by my colleague, Professor M'CLEOD. I also owe much to his sympathetic aid in the making and use of the vacuum apparatus to be described below.

drawn end sealed. The drawn ends were then broken by means of forceps in the nutritive fluid employed, the latter having been freshly boiled for some time, and being still almost boiling; they were then sealed again, and heated for several hours on two or three successive days. When finally cool, they were infected, and again attached to the pump and exhausted; then, while vapour was being driven through the drawn necks, they were finally sealed. The Schizomycete increased considerably in those tubes infected with the Ginger-beer plant, and at one time I proposed to use this method to separate it from the yeast; but the internal pressures became so great, owing to the large quantities of carbonic acid gas formed, that several of the tubes burst spontaneously—one as I held it in my hand—and I had to abandon the method on account of its danger. It is true I have occasionally continued its use, with such precautions as wire-gauze jackets, &c., to the tubes, but another plan was finally adopted instead, as follows:—

With Professor M'CLEOD'S assistance, the apparatus shown in fig. 6 was made. The tube *f* is detachable from the piece *a*, *a'*, *b*, and these are sterilised by heat; the glass tube *m*, and the mercury it contains, are also heated, as is also the cork collar *k*. The piece of caoutchouc which joins the two tubes (near *w*) is carefully sterilised by corrosive sublimate, absolute alcohol, and boiling.

The tube *f* is then charged with the nutritive liquid to be used, and plugged with sterilised cotton-wool (*w'*), and the whole kept at 80° to 90° C. for several hours, on at least three successive days. The liquid in *f* is then infected, and the tube plugged (*w'*), and joined to the sterilised tube *a*, *a'*, also plugged at *w*. The joint is completed by filling *m* with previously heated mercury.

The tube *a*, *a'* is then connected to the mercury pump by *x*, and a vacuum produced, the tube *a*, *a'*, being finally warmed to drive out the last traces of air by vapour. When the click of the mercury has reached its best, and remained at it for some time, the pump is stopped.

After a few hours the exhaustion is repeated, vapour and a trace of gas being obtained; the gas is totally absorbed at once by potassic hydrate. These successive exhaustions are continued at intervals of six to twelve hours for three days, and then the culture is left to itself for periods of twenty-four to forty-eight hours, or longer.

It will be best to follow the details in a concrete case.

The sterilised tube, filled with equal volumes of PASTEUR'S solution and bouillon, was infected on September 11th with a trace of the white gelatinous cushion, at the bottom of a pure culture of *Bacterium vermiforme*, and exhausted very thoroughly at 3.30 P.M. Temp. = 20° C.

On September 12, the pump-apparatus was again set going; the vacuum was very good, nothing but vapour being obtained. Repeated the exhaustion in the evening—same results. It was then left until September 14. On starting the pump, the click again indicated much vapour, but on examining the graduated catch-tube of mercury placed over the escape-tube of the pump I found two divisions of gas in the

eudiometer tube employed to collect it, apart from the condensed vapour. This gas was all absorbed by potassic hydrate. The exhaustion was repeated in the afternoon, and more vapour obtained. Similarly on the 15th, a loud sharp click being left each time, indicating a good vacuum.

The loss of vapour was now telling considerably on the quantity of liquid in the culture-tube, so I placed a small flame near the tubes, *a*, *a'*, and *b* (fig. 6), and a

Fig. 6.

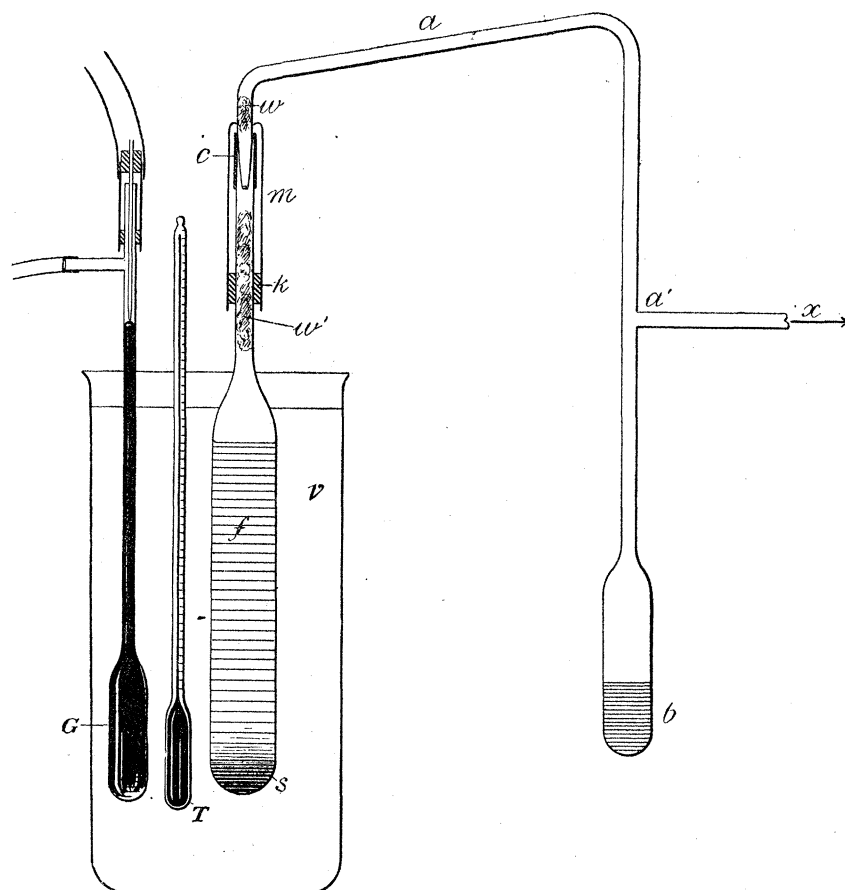

Apparatus for cultures *in vacuo*: *a*, *a'*, glass tubing attached to mercury pump beyond *x*; *b*, a bulb for condensed vapour; *w*, cotton-wool plug in the sterilised tube *a*; *w'*, similar plug in the sterilised tube *f*, which contains the culture growing at *s*; *c*, caoutchouc-tubing connecting the tubes *a* and *f*; *k*, cork-ring, and *m*, glass tube filled with mercury and making a gas-tight junction over *c*; *v*, glass beaker containing water; this is placed over a small burner connected by tubing with the gas-regulator *G*; *T*, thermometer.

thermometer, and caused a slow backward distillation into *f* by keeping the temperature of these distal parts of the apparatus a trifle higher than that of *f*. This device only partially succeeded, but it lessened the loss somewhat.

On September 15, I could distinctly see that the mass of organism was increasing

in *f*. On the 17th, I pumped off five divisions of carbon dioxide; there was no other kind of gas evolved, now or at any other time.

On September 30—the apparatus and contents having remained untouched during the interval—the starting of the pump at once showed that much gas was present, and I collected eighteen divisions of carbon dioxide.

On October 1, five more divisions of CO₂ were pumped off; on October 3, eight divisions; on October 5, five divisions; on the 6th, four divisions; on the 7th, two divisions, and so on.*

The gas was allowed to accumulate in the catch-tube from the 5th October to the 20th; the total volume was just over twenty divisions.

The apparatus was again left quiet until November 3, and on again exhausting on that day, I obtained eleven divisions of carbon dioxide; temp. = 10° C. On November 9, I obtained a few divisions more, but did not measure them, owing to my finger slipping and letting air into the measuring tube. Temp. still = 10° C. I now (November 9th) again raised the temperature of the culture to 25° C., and left the apparatus alone until November 14.

During all this period a slow but quite perceptible growth had been going on daily in the culture medium in the tube *f*, and there was now a flocculent cloud extending half-way up the tube: this evidently corresponded to a material increase of the organism, at the expense of the nutritive materials in the medium—unless we assume that the increase was a mere volumetric one, and that the carbon dioxide coming off was due to decomposition of the proteids, &c., of the bacterium—an assumption which the sequel shows was impossible.

On November 14, the pump again brought off carbon dioxide, and evidently would have yielded much more, only I stopped it after a few divisions were drawn off. On the 18th I pumped out thirteen divisions of carbon dioxide.

It will be noticed that the total volume of carbon dioxide obtained amounted to more than sixty-nine divisions, and that more would have been obtained had I carried the experiment further.

I stopped the experiment at the point referred to, because I wanted to answer two questions with regard to which doubts might possibly arise. First, however, it should be stated, that although the organism had been in the apparatus, and deprived of atmospheric oxygen, for more than six weeks (September 11 to November 18), and had enormously increased in volume, and presumably in weight, it was noteworthy that no characteristic gelatinous cushion had made its appearance.

I argued that this might possibly be owing to the fact that I had been drawing off the carbon dioxide, almost as fast as it was formed, and that probably—judging from what occurred in similar cultures in an atmosphere of carbon dioxide—the cushion would form if I let that gas accumulate.

* The temperature of the tube *f* was allowed to fall to 10°–12° C. between the 8th and the 20th.

Since it would not do to leave the apparatus as it was until the pressure of gas dislocated the mercury junction with the pump, I sealed off the tube *f* with a blow-pipe flame* just below the cotton-wool *w'*, and put it aside at 25° C.

The two questions referred to above could now be answered. The questions were:—(1) Had the organism really lived and grown all this time in the vacuum-tube *f*? and (2) Would it develop into the typical sheathed form of the Schizomycete if left in the atmosphere of CO₂ produced by its own metabolic activity?

Both questions received their definite and satisfactory answer. On November the 18th, the loose, cloudy, slightly flocculent mass extended about half-way through the lower part of the liquid, which half filled the tube; as we have seen, the tube also contained a partial pressure of CO₂ and vapour of water. Prompted by previous experience with sealed tubes (see p. 170), I wrapped this one in wire-gauze, and placed it in the incubator at 25° C., as said.

In a few days the typical gelatinous cushion made its appearance, and on December 5th I held the point of the sealed tube in the flame of a Bunsen's burner until soft, and noticed a sharp puff which blew *outwards* a minute hole in the side of the tube.

I then made a series of sowings from this tube into ordinary tubes of bouillon-Pasteur (twelve in all), and put them into the incubator at 25° C., with sterile check-tubes by their sides; all succeeded, and followed the normal course described on pp. 166–169.

Clearly the organism was not only alive, but was capable of forming the typical sheathed form, and thus were answered the two questions referred to. It must, therefore, be concluded that this remarkable Schizomycete is able to live and grow in an acid saccharine solution, with suitable minerals and nitrogenous materials, not only in an atmosphere totally deprived of oxygen, but in one of vapour, and which is so attenuated that it is practically a vacuum—so far as permanent gases are concerned—but that it only forms its gelatinous sheaths if carbon dioxide is present.

It is interesting also to note that the exposure to ordinary daylight, at least, does not kill the bacterium in the vacuum or other cultures.†

It ought to be added that I have confirmed these results by several experiments with the above apparatus, and in no case found the Schizomycete killed by even more continuous exhaustion than these. So successful were such cultures that I entertained the idea of using the method for separating the bacterium from foreign organisms for pure cultures.

* It should be noted that there was more room below *w'* than appears in fig. 6, and that no burnt cotton-wool interfered with this operation.

† I say no more on this subject, because it is possible that light has some effect on the cultures under certain conditions; the point deserves special investigation, and I have experiments in hand.

Schizomycete No. 2.

Recorded in my notes as the Ginger-bacillus. (Plate 15, figs. 1-6.)

In the early stages of the investigation I was much concerned with a very pretty and well-marked Schizomycete, met with in some of the separation cultures, and easily cultivated on gelatine.

From suspicions aroused by the frequency of this form in fermentations, to which lumps of unsterilised ginger were added, I was led to look for the bacillus on ginger-rhizomes, and found that on putting these into sterile glucose solutions, it appeared frequently in twenty-four to forty-eight hours. Hence the name Ginger-bacillus.

In such cultures it formed a dense whitish membrane on the surface, composed of closely woven and often parallel filaments, about 1 to 1.5 μ broad, and of various lengths (Plate 15, fig. 1, A and B). These filaments were septate (B), and broke up into zigzag jointed rodlets, 10-12 μ or more in length (A).

Cultures of these filaments on gelatine showed the breaking up still more clearly (fig. 2) into bacilli, and forty-hours later these bacilli were replaced by definite spores (fig. 3), measuring about 2.5 μ \times 1 to 1.5 μ . These spores were easily obtained after five days' culture on gelatine-glucose (fig. 4), and showed that the bacillar rods or filaments swell to an elongated oval, or blunt spindle, before developing the oval spore.

In fig. 5 I have recorded the chief stages in the life-history, as traced in a hanging drop of PETER'S gelatine. The spores (fig. 5, A), were sown on January 10, at 4 P.M., and the culture placed in the incubator at 27° C. At 9 P.M. on the next day, they had germinated and given rise to rodlets and filaments, the latter disjoining into rodlets (fig. 5, B). At 10 P.M. on January 12, many of the rodlets were swelling up, and, forming the oval spores (fig. 5, D), others were still in the stage of filaments, breaking up into bacilli (fig. 5, C).

The germination of the spores was also observed in a hanging-drop of gelatine-glucose. (Plate 15, fig. 6.)

I have not been able to definitely identify this form with any known species of Schizomycete, but as I regard the investigation of its life-history and properties as still incomplete, it would be premature to propose a name for it as a new species.

Grown in PASTEUR'S solution with sterile ginger and asparagin, it rapidly passes through the filamentous and bacillar stages (which may be motile) to the formation of the endogenous spores, as described, but I failed to grow it in Pasteur-asparagin alone, prepared so that no inversion of the sugar occurred. I attributed the difference to its inability to invert cane-sugar, but desire to put forward this explanation with all reserve.

It grows readily on nutrient gelatine, especially with 5 per cent. of glucose, rapidly liquefying the gelatine, and passing through all its stages to the development of spores, which fall to the bottom of the cultures.

I failed to grow it on yeast-water gelatine, unless glucose was added. On PETER'S gelatine it did remarkably well, forming thick grey-white crumpled films, looking like miniature honey-combs, and eventually developing spores as described.

That it is an aërobic form was abundantly proved by the failure of all cultures in CO₂. It also failed in vacuum tubes.

During a certain period of the preliminary cultures, I confounded this form with another which also liquefies the gelatine, but produces a greenish shimmer in the matrix.

My reason for not attempting to thoroughly unravel the life-history of these forms will be readily understood; it soon became quite certain that they had nothing to do with the formation of the Ginger-beer plant (see p. 138) and so I abandoned the further pursuit, as it was necessary to concentrate all my energies on the essential forms.

The above ginger-bacillus presents some resemblances to *Bacillus subtilis*, but seems to me larger, and the shapes and sizes of the sporogenous rods and spores are different. The sizes accord better with COHN'S *Bacillus ulna*, but the oval sporogenous cells are different. The latter recall PRAZMOWSKY'S *Clostridium butyricum*, but that is markedly anaërobic; the habitat would do very well, and the curious spores and germination seem to accord, though the sizes of mine are somewhat larger.

On the whole, it seems wiser to be content with merely recording the presence of this form, leaving questions as to its name and position until its characters have been more fully worked out.

Schizomycete No. 3.

Bacterium aceti (KÜTZ.). (Plate 15, figs. 7-9.)

In all the specimens of Ginger-beer plants sent to me, I found varying quantities of a small bacterium (about 1 to 1.5 μ long, and 0.3 to 0.5 μ broad) which turned out to be the well-known bacterium of acetic acid fermentations. The acid smell and reaction referred to on p. 127 are principally due to this intruder.

Two facts made it necessary to undertake the further investigation of this Schizomycete, however; to say nothing of the recent discovery that there are at least two physiological forms (races or species) of the organism, viz., the ordinary *Bacterium aceti* (KÜTZ.), and HANSEN'S *B. pasteurianum*, which only differs in that it turns blue in iodine owing to the presence of a starch-like substance in the matrix surrounding its protoplasm.*

These facts are, first, that the bacterium of the acetic ferment forms a well developed and even massive zooglœa-like skin in which yeast-cells and all kinds of organisms may

* See HANSEN, 'Meddelelser fra Carlsberg Laboratoriet,' H. 2, 1879 (quoted by JORGENSEN, 'Die Mikro-organismen der Gährungsindustrie,' 2^{te} Aufl., 1890, pp. 43-47). Also A. BROWN, in 'Journ. of Chem. Soc.,' 1886 and 1887, vols. 49 and 51.

become imbedded—the so-called “mother of vinegar”—and, secondly, nearly all the preliminary cultures and all the samples of ginger-beer I examined went “sour” after a time if air gained access to them, and the sourness was found to be accompanied by this bacterium, and due to acetic acid, as could be detected, indeed, by the smell in old cultures.

In some cultures of the 1889 and 1890 series especially, I observed a very curious and penetrating odour of acetic ether (ethyl acetate), so strong that it pervaded the whole laboratory, escaping through the cotton-wool plugs of the flasks, and from beneath the bell-jars covering them. This was found to be due to the co-operation of the very small and white top-yeast (see yeast, p. 149), and the bacterium in question, and was explained as due to the yeast producing more alcohol than the bacterium could completely oxidise to acetic acid; consequently the mixed vapours of alcohol and acetic acid escaped together and combined to form the very fragrant ethyl acetate. It was impossible for me to go further into this phenomenon, which, like others which turned up during the investigation under consideration, seems well worth the attention of the biological chemist; but I, at least, established that while, in the first place, neither the bacterium nor the yeast was able to produce the compound mentioned when working alone, it was, in the second, very easy to repeat the phenomenon by adding the two organisms to a saccharine solution.

We are more particularly concerned, however, with the properties and life-history of the bacterium itself.

It was comparatively easy to isolate the Schizomycete by placing it in solutions too acid to permit the development of the yeasts, and I found it to agree in all respects with the well-known descriptions given by the chief authorities. Not only so, but I compared it with pure cultures obtained by the kindness of Mr. ADRIAN BROWN, who has devoted much attention to this species, as already quoted.

It suffices to add that subsequent cultures demonstrated, not only that this bacterium is not a normal or necessary constituent of the Ginger-beer plant, but that it cannot be induced to form a submerged commensal growth with any of the yeasts.

It is so markedly aërobic that no wonder can now be entertained at this; however, it was necessary to test the point, because the dense skins of the “mother of vinegar” present considerable likeness to the gelatinous investment of the Ginger-beer plant.

Other Schizomycetes.

It was to be expected that various casual bacteria would occur as intruders in the very numerous tube- and flask-cultures, and such was the case. Some of these were obviously forms introduced as impurities in the process of opening and examining the tubes, or of preparing food-materials, and so forth. These were not numerous, and cases of the latter kind of impurity rarely occurred, except with certain media, very difficult to sterilise in the summer—*e.g.*, milk, decoctions of beet, plums, and ginger.

I neglect any further account of such forms as were traced to these sources, and confine my remarks entirely to forms really carried in with the specimens of Ginger-beer plant.

One of the commonest of these, though by no means a constant accompaniment, was a very minute micrococcus, forming *Ascococcus*-like colonies in the matrix of some of the hanging-drop cultures of *Bacteriumm veriforme*, and figured on Plate 15 (fig. 11).

It was an extremely minute form, and appeared to constantly reproduce in the micrococcus mode. I was unable to render any account of it, beyond observing that it seemed to do best in the cultures in beet-gelatine. It was always closely associated with the matrix of *B. veriforme*, and even suggested parasitism, but, although I tested the idea to some extent, nothing definite came of it.

The coccus itself was less than $1\ \mu$ in diameter, the colonies white. It did not liquefy gelatine, nor would it grow on that substratum to any observable extent.

A second Schizomycete, also of comparatively rare occurrence, was a slender filamentous form, only found in the earlier cultures, and lost before it could be separated.

In some of the earlier cultures in ginger solution, a beautiful micrococcus in long chaplets was met with. It was associated with a fragrant smell, like that of burnt or smoked sugar. I paid some attention to it in 1889, because the fragrance was not unlike that observed in some specimens of ginger-beer; it was so assuredly not concerned in the building up of the Ginger-beer plant, however, that its behaviour was not followed further.

Two other forms may be just referred to, though they only occurred once—each in a set of cultures which gave me trouble in connection with the isolation of the constituents.

One of these was a rather large micrococcus, which formed yellow patches on yeast-water gelatine. It was almost certainly *M. aurantiacus* (SCHRÖT.), and I dismissed it after identification. It came in specimens of the Ginger-beer plant obtained from Coventry.

The other was a small micrococcus, which grew rapidly on gelatine, liquefying it, and causing a putrid smell. It only occurred in one set of cultures in 1889, and was also traced to the Coventry specimens, which were very much contaminated.

I have only mentioned the two last forms because they impressed me with the possibility that these lumps of Ginger-beer plant, handed from family to family as they are, may carry in them all kinds of microbes, of course, including even pathogenic forms. The same idea occurred, quite independently and on other grounds altogether, to a medical man in the midland counties, who sent me specimens of the Ginger-beer plant, with the remark, "I was rather surprised to find not only torula-like bodies, but a regular mycelium, which in cover-glass preparations bore some resemblance to that of the *Actinomyces*. I have, however, formed the opinion that the two are quite different, and that the fungus has no connection with this disease."

The last sentence refers to my correspondent's suggestion (in a previous letter) that a patient of his who gave him the specimens might have contracted his malady (which turned out to be due to *Actinomyces*) from partaking of ginger-beer made with the Ginger-beer plant. I think the suggestion was decidedly worth the investigation, though, happily, it turned out to be wrong in the present instance.

Higher Fungi occurring as Impurities in the Ginger-beer plant.

I have now concluded the biological analysis of the Ginger-beer plant, so far as the essential constituents, and the commonest foreign yeasts and Schizomycetes are concerned. It remains to place on record, however, the existence in the specimens examined of a number of higher mycelial forms of fungi, which, different as they are in detail, may all be regarded as of the nature of "moulds."

Looking at all that is known of the lumps of Ginger-beer plant, and how they are handed about in the fresh state, and remembering the way the ordinary fermentations are carried on in country houses, &c., it might be predicted off-hand that all kinds of spores of common mould-fungi would get into the mixtures and contaminate them. As matter of fact, I never had a specimen of the Ginger-beer plant sent to me that did not contain several species of these mould-fungi. I attribute the presence of these intruders to three chief sources:—

(1.) To the ingredients employed—ordinary unboiled spring-, well-, or tap-water, common sugar and ginger direct from the grocer's, and, of course, unsterilised. Proof of this may be obtained by anyone who places a solution of ordinary sugar and water, with a lump of ginger in it, in an open vessel, and in a rather warm room, for forty-eight hours or so; the brew swarms with yeasts, bacteria, and mould-fungi of various kinds.

(2.) To the vessels—ordinary jugs, jars, pipkins, &c., of a household—the walls of which are, of course, never biologically clean without special treatment.

(3.) Contact with the hands, pieces of paper or cloth, and exposure to air, as the specimens are passed from one person to another.

I have by no means attempted to exhaust the list of forms that might be observed if one made a systematic search through the specimens; but since one or two interesting species turned up during the earlier stages of the enquiry, when my mind was clear of any preconceived ideas, and ready to receive any form as possibly concerned in the constitution of the Ginger-beer plant, it may be worth while to record what was made out about them.

I will first take a large yeast-like form, which was particularly abundant in the separation cultures of one set of specimens examined in 1888. It is figured on Plate 15, figs. 12 and 13.

It occurred as yellowish-white, pasty masses of cylindroid-oval cells, with delicate walls and vacuolated protoplasm, forming dense films on the surface of the cultures, or thick deposits at the bottom. These cells were either isolated or united in

imperfect chains of two, three, or more, or had protuberances budding from the sides of their ends, like the budding of a yeast (Plate 15, fig. 12).

One of these cells, isolated in a hanging-drop of peptone-gelatine, germinated in a few hours, giving rise to a mycelium, which, in twenty-three hours from the moment of sowing, had attained the relatively large dimensions shown at Plate 15, fig. 13, γ , and in forty-eight hours was breaking up, by abscission of its joints, into the cylindroid yeast-like cells started with.

On sowing these cells again in PASTEUR'S solution, Pasteur-glucose, and in ginger-Pasteur, they again behaved like a yeast, the buds breaking off as soon as formed, and a feeble alcoholic fermentation was induced.

It was interesting to note that in tubes of nutrient gelatine, the hyphal form penetrated into and partly liquefied the gelatine. I have not obtained any higher development of this fungus than the forms described, but it is by no means improbable that *Oidium* is merely a growth-form of some higher fungus, possibly of a Hymenomycete.*

In form, size, and general behaviour, this fungus agrees so well with all the descriptions of *Oidium lactis*, that I have no hesitation in referring it to that species, unsatisfactory as the form is from the points of view of modern biology.

I have already referred (p. 144) to my failures to confirm CIENKOWSKY'S suggestion that *Oidium* and *Mycoderma* are identical. It seems likely that a thorough investigation of *Oidium lactis* would repay any competent worker. It would be especially worth while to see if *O. lactis*, growing on gelatine, produces lactic acid, as seems to be the case.

Another of the queer mould-fungi which I isolated from odd specimens of the Ginger-beer plant, is the form long known under the name of *Dematium pullulans* (DE BARY). It first turned up on some lumps of Ginger-beer plant which had been plunged into boiling water and put aside in a dry sterilised flask, plugged with sterile cotton-wool. This flask was placed in a glass cultivating-chamber, heated with hot water to 20°–25° C.; it stood fully exposed to light. The pieces of Ginger-beer plant had been washed in boiling distilled water, and placed as said to see if the Schizomycete could be induced to form spores in the interior of the lumps.

In two or three days a brownish-yellow hue appeared—as is usual when the plant is allowed to dry. In about a fortnight the brown colour was much deeper, and within the month the whole mass was covered with a dull, dark brown film, which on examination was found to consist of countless numbers of cells like those represented in fig. 14, A, Plate 15. As there seen, some of the cells were almost colourless, others, surrounded by a firmer wall, were umber-brown in colour. They

* See BREFELD, 'Unters. aus d. Gesamt-Gebiete der Mykologie,' H. viii., 1889, especially Plate 2, fig. 22; Plate 4, fig. 25; Plate 6, fig. 5, &c.

varied much in size* and shape, some being spheroidal, others ellipsoidal or sausage-shaped; some were septate, some in chains of three or more, and others again had colourless hyphæ, about 3–4 μ in diameter, in connection with them. All the darker ones and most of the others contained much oil in the form of drops scattered through the protoplasmic contents.

These cells grew readily in ginger-gelatine, and the further development of the specimen fig. 1, α (Plate 15) was traced in this medium, in a hanging-drop under the microscope. Similarly with the series d to g and x , in the same figure. On Plate 16, I have depicted the behaviour of a more complete culture obtained by sowing the segment α at 4 P.M. on February 14, in a hanging-drop of HAYDUCK'S glucose-gelatine. The arrangement was as described on p. 131. It germinated rapidly, as shown at b and c , at about 17° C., and in a little more than two days had formed a copious mycelium (f) throwing out buds from numerous points of the older segments of its hyphæ. The details of the development of these buds were also traced (g to l , Plate 16,) and a full description of the figures is given with the plates.

Interesting† as the further pursuit of this form would have been, I had to abandon it, after satisfying myself of the want of genetic relations between it and the Ginger-beer plant. I hope to follow out its life-history at a future opportunity. In addition to the above, I have at various times isolated a curious form—or perhaps series of forms—of *Torula*, consisting of isolated spheroidal cells varying in colour from brown to green and greenish-blue. Beyond having proved that it is capable of developing a mycelium, which is septate, I have not gone further into the life-history of these. They were obviously intruders, and only occurred occasionally.

For the sake of completeness, I may add that *Penicillium glaucum* was a frequent impurity in the Ginger-beer plant, and that a *Mucor* (apparently *M. racemosus*) made its appearance once.

SYNTHESIS OF THE GINGER-BEER PLANT FROM PURE CULTURES.

The most conclusive proof of the accuracy of the foregoing studies, must evidently be afforded by my being able to re-constitute the Ginger-beer plant, as such, by bringing together pure cultures of the organisms composing it, and showing that the specimens so produced act like the original specimens. This I have done, and so

* The brown cells average 8–10 μ long by 6–7 μ broad; colourless buds in gelatine (which they liquefy) average 2–8 μ long by 1–3 μ broad.

† See LAURENT "Recherches sur le Polymorphisme du *Cladosporium Herbarum*" ('Ann. de l'Institut PASTEUR,' vol. 2, 1888, pp. 558 and 581), where he claims *Dematium* as a mere growth form of this fungus. LAURENT'S results are particularly interesting in view of the similar results with a totally different mould-fungus (*Eurotium Aspergillus glaucus*) by ELFVING ('Studien über die Einwirkung des Lichtes auf die Pilze,' Helsingfors, 1890.) ELFVING asserts that several races of growth-forms can be got from this fungus by altering the conditions.

completely that no further doubt need be entertained as to the biological nature of the phenomena concerned.

After satisfying myself that *Saccharomyces pyriformis* is the essential yeast concerned, I determined to attempt to build up the compound organism again, by adding pure cultures of the different Schizomycetes, in turn, to pure cultures of this *Saccharomyces*.

But, in order that there should be no stone left unturned in the research, I also brought together, in turn, each of the yeasts or yeast-like forms which occurred commonly in the investigation, with each of the bacteria or other Schizomycetes which forced itself into the foreground of the experimental cultures. I thought it not impossible, moreover, that there might be more than one combination capable of existence as a dual or symbiotic form. With these ideas in view I started with *Mycoderma cerevisiæ*. Having prepared pure cultures of this, I infected them in turn with (1) the ginger-bacillus, (2) *Bacterium aceti*, and (3) *Bacterium vermiforme*, but in no case with success.

The strongly marked aërobian character of the *Mycoderma* was itself sufficient to make the attempt almost hopeless; and I found that in no case would the cultures endure being bottled up away from the air. In the more suitable saccharine media, some growth of the *Mycoderma* was observed, but only at the top of the liquids, and evidently only so long as the air in contact with it (and dissolved in the liquid) lasted. In neutral gases, in carbon dioxide, and *in vacuo*, the *Mycoderma* rapidly succumbed.

The Schizomycetes behaved variously. The acetic bacterium died rapidly when continuously submerged. The ginger-bacillus grew at first, but soon became converted into spores, which fell to the bottom of the cultures, and remained dormant among the dead and dying *Mycoderma* cells.

The *Bacterium vermiforme* did not so rapidly succumb, but generally broke up eventually into short rodlets and cocci, and never formed the typical cushion-like gelatinous masses of successful cultures. At the same time, it often commenced to form the sheaths, *e.g.*, in HAYDUCK'S solution, and in Pasteur-bouillon—but no symbiotic relations were established between these and the *Mycoderma* cells. The death, or abeyance of the latter, in such solutions, is perhaps not to be wondered at, when we remember that *Mycoderma* is incapable of inverting cane-sugar; but it must not be overlooked that such inversion might be brought about by the Schizomycete.

It was pretty clear, from these experiments, that the *Bacterium vermiforme* is not a mere saprophyte, which lives on the débris of any haphazard yeast-like form in the medium, a conclusion fully borne out by the sequel.

I then tried cultures of *Oidium lactis*, together with the above forms, in succession, but with negative results in all cases.

Similarly with the "rosy yeast," which, moreover, seemed to rapidly succumb to every attempt to confine it from the free access of air.

One series of attempts was also made with the small white aërobian yeast, referred to on pp. 148 and 149, again without success. It was interesting to note, however, that when this form was sown with *Bacterium aceti*, on saccharine media, to which the air had access, they formed the acetic ether referred to (p. 176), and it was this which led me to the conclusions already stated, viz., that a sort of symbiotic life is led by the two organisms, side by side, on the top of the aërated liquid; the yeast produces alcohol, in virtue of its fermentation powers, which the bacterium oxidises more or less completely, one of the products being the fragrant acetic ether referred to.

The only other yeast of importance was the one I have named *Saccharomyces pyriformis*.

This yielded no results when sown in company with the ginger-bacillus. In some cases the latter seemed to be suppressed altogether, though in others the Schizomycete formed numerous spores, which could be detected, mixed with bacillar rodlets, at the end of the fermentation (due to the yeast alone) in the deposit of yeast-cells. No trace of anything like the Ginger-beer plant could be detected in any of the cultures.

Complete failure also attended every attempt to combine the acetic bacillus with the *Saccharomyces* in question. I have said that I was attracted at an early period in the investigation by the notion that the dense gelatinous skin (zoogloea) which the acetic bacillus forms on the top of vinous media presents some resemblances to the gelatinous masses due to the coiled sheaths of the *Bacterium vermiforme*. This notion had to be abandoned, however, because, on the one hand, the skin formed by *Bacterium aceti* is strongly aërobic—whereas the gelatinous cushions of *B. vermiforme* are formed best in carbon dioxide—and, on the other, all attempts to grow the acetic bacterium submerged with yeast failed: the rodlets of the acetic Schizomycete simply fell down in the closed tubes, turned yellowish-brown, and died.

The results obtained by cultivating together, in the same medium, the two forms, *Saccharomyces pyriformis* and *Bacterium vermiforme*, were eventually so successful as not only to exceed all my most sanguine expectations, but also to throw considerable light on this most remarkable dual organism—the Ginger-beer plant. Nevertheless, it is necessary to fulfil certain conditions in order that the synthesis referred to may be established.

In cases where I employed bouillon as the medium no appreciable success was obtained. The yeast-cells budded very slowly, and although they became enveloped by the rapidly dividing bacteria (Plate 14, fig. 10), the latter developed no gelatinous sheaths, and consequently no gelatinous lumps were made.

In bouillon-glucose the yeast did much better, and the bacterium grew out long rods and filaments (Plate 14, fig. 9) which seemed to promise more success. Nevertheless I was unable to produce satisfactory clumps of the Ginger-beer plant

as such, in this medium, even after several weeks, except in one or two cases, which had then ceased to be interesting on account of success in other directions.

Things were very different in those cases where bouillon-Pasteur was employed, and at last I hit on a method which seems as if it would enable one to produce almost any desired weight of the Ginger-beer plant at will.

I have already described (on p. 160) how successful were the cultures of the *Bacterium vermiforme* in tall glass cylinders, containing Chamberland filters charged with the *Saccharomyces pyriformis*, and I pointed out then that the successful development of the bacterium was probably due to the culture-medium being simultaneously affected by the action of the *Saccharomyces* on the other side of the (for the organisms, but not for soluble matters in the liquid) impenetrable porous porcelain wall of the Chamberland tube.

I found, now, that if I infected the liquid containing the bacteria on the outside of the Chamberland tube (see fig. 4, p. 160) with a little of the yeast grown apart *inside* the Chamberland tube, typical lumps of the Ginger-beer plant were developed in a few days. These lumps were formed by the coils of the sheathed bacterium entangling the yeast-cells (Plate 14, fig. 11), but the most extraordinary result, to my mind, was that both yeast and bacterium seemed to gain in activity as soon as they came into direct contact in the embraces of the latter. This enhanced activity was not shown merely by the more active budding of the yeast-cells and the growth of the bacterial coils: it also manifested itself in the steady and continued evolution of large quantities of carbon dioxide, bubbles of which rose from the lumps of Ginger-beer plant, and often buoyed them up to the top, whence they then descended as the gas escaped from their surfaces.

The experiments just described, when compared with some of my previous attempts to re-construct the Ginger-beer plant from its constituent organisms, led to some observations which seemed instructive.

In the first place, it only required a few days in these cases to make the yeast and the bacterium effect their symbiotic union, whereas I had found that in cultures in ordinary test-tubes it often needed several weeks—three to six—to establish the union. This was not due to difference of temperature, though temperature, of course, affects the question, as also do the media.

I found, in fact, that if I prepared pure tube-cultures of the yeast (*S. pyriformis*), and then added a few drops of a pure culture of *Bacterium vermiforme*, the union of the two was often delayed. Putting aside all cases obviously depending on differences in the mode of culture of the two samples, it at last became clear that some of these partial or temporary failures were due to the fact that at the time I added the bacterium, the yeast had already finished its fermentation of its own culture-medium—the primary fermentation was over, and the medium exhausted. If the reader chooses so to express it, the medium was yeast-sick!

Now we are justified in inferring from all that is known of such fermentations—

it has been shown that *S. pyriformis* induces an alcoholic fermentation—that they come to an end owing to the inhibitory action, on the yeast-cells, of the products of fermentation; and that these products, as they accumulate in the fermented liquid, undergo further alterations which entirely alter its nature.

In view of the above, it seems impossible to avoid the conclusion that the delay in forming the symbiotic union, when the bacterium is added to an already advanced culture of the yeast, is due to some difficulty which the Schizomycete meets with in the altered medium. This difficulty might be one of the three following:—

Firstly, it might be simply due to the quantity of bacteria being so small that time is needed for their multiplication in the medium, and for the development of sufficient of the sheathed coils to fully entangle and embrace the large supply of yeast-cells.

Secondly, it might be due to the fact that the yeast-cells are now in an exhausted condition, whereas the Schizomycete only enters into symbiotic relations with active yeast-cells.

Thirdly, it might be due to some inability on the part of the Schizomycete to assimilate substances left in the medium by the yeast-cells.

I came to the conclusion that the first explanation is not the right one, because similar delays were met with if I added larger quantities of the bacteria to such yeast-cultures, and I could detect no correspondence between the time occupied in effecting the symbiotic union, and the numbers of Schizomycetes added.

It is less easy to decide with respect to the second and third possibilities. The successful cultures of the bacterium on the outside of the porcelain tube, containing the yeast, seem at first sight to preclude the idea that the medium is rendered unfit for the growth of the Schizomycete by the soluble products of the fermentation due to the Saccharomycete, since these products must have diffused through the porous porcelain. But it must not be overlooked that these products may be very different at the beginning and at the end of the fermentation; and that they may be, and probably are, unstable bodies when they first leave the yeast-cells, which alter as they pass out into the surrounding liquid. In the latter event they might become less useful to the bacterium growing at a distance from the yeast—*e.g.* on the distal side of the porous septum—than they would be when newly formed, and when the Schizomycete, in direct contact with the yeast-cells, can take them at first-hand.

Everything points to the view that the relations between the yeast and the bacterium are those of true symbiosis, because every attempt to feed the Schizomycete with dead yeast-cells, or decoctions of such, or to detect it embracing such cells in a dead or feeble condition has failed.

It is significant that the synthesis of this dual organism—which is so strikingly like a Lichen that we may compare it forthwith to one of the gelatinous forms—was most easily brought about by adding the yeast-cells to already advanced cultures

of the bacterium, both having been grown in the same medium, and under like conditions.

This, and the previous considerations, led me to the conclusion that we must look on the symbiosis somewhat as follows:—

The Schizomycete is favoured by obtaining some substance or substances directly they leave the sphere of metabolic activity of the yeast-cells; it can benefit by the presence of these substances even apart from the living yeast, though to a less extent.

The yeast, on the other hand, benefits by these substances being removed and destroyed, hence its renewed and continued activity—as evinced by the steady and copious evolution of carbon dioxide for weeks, and the corresponding increase of the yeast-cells by budding—when the symbiosis is established.

For the present this can only be regarded as a hypothesis. It might be objected that I have inverted the order of events—that, since the Schizomycete is able to evolve small quantities of carbon dioxide daily, from saccharine solutions, it may be that *its* powers are enhanced by the yeast-removing inhibiting substances of its activity. The objection is possibly valid, but I think the former hypothesis explains most facts: how, for instance, is it to be explained that the Schizomycete slowly and steadily converts the whole of the liquid sugar-solution into a solid gelatinous mass, if the organism excretes such inhibiting substances?

All these questions must wait for answers, however, until we obtain some knowledge of the products of the several fermentations, and compare those formed by the two organisms separately, with those developed by the symbiotic Ginger-beer plant as a whole.

CONCLUSION.

In conclusion, it may be pointed out that my researches have so far been directed almost entirely to elucidating the morphology and physiology—*i.e.*, the biology—of the dual organism known as the Ginger-beer plant. Undoubtedly there is a promising field for investigation in connection with the chemistry of the fermentations; not only those due to the action of each organism—the yeast and the bacterium—by itself, but still more the symbiotic fermentation due to the Lichen-like compound organism.

I have proceeded some little distance in this direction, but only sufficiently far to show that in addition to the large quantities of carbon dioxide evolved, the ginger-beer contains traces of alcohol and acetic acid during early stages of fermentation, and that relatively large quantities of some body resembling (if not identical with) lactic acid are formed. The details of this question can only be determined by quantitative methods and combustions, which have not as yet been undertaken systematically.

I have also made some biological examinations of bottled ginger-beer (so-called home-made). In addition to yeasts of various kinds and several species of bacteria,

I have isolated from two different brands certain minute micrococci which appear to be identical with those on Plate 14, fig. 6.

The origin of the Ginger-beer plant is, as has been stated, involved in obscurity, but there is evidence to show that the yeast (*Saccharomyces pyriiformis*) is introduced from the grocers' shops attached to the ginger and brown sugar employed in ordinary practice, while the bacterium (*B. vermiforme*) is introduced with the ginger. In one series of experiments this was very clearly the case. A number of sterilised soda-water bottles were three-parts filled with the saccharine liquid, and charged with ginger and sugar as follows. Some had sterilised sugar and a lump of unsterilised ginger; others had both ginger and sugar non-sterilised; and the rest had both sterilised.

Unfortunately I have not had time to continue these experiments far enough, and it was decidedly an oversight not to weigh the quantities of ginger and sugar employed; and still more so not to employ non-sterilised sugar and sterilised ginger in the same series. Other series with the latter gave negative results.

Be this as it may, in two of the flasks with both ginger and sugar not sterilised the Ginger-beer plant made its appearance after 10 weeks, suggesting that both yeast and bacterium were introduced with the sugar, or the ginger, or both. The negative results with the ginger, excepting that I found the yeast on it, suggested that the bacterium was introduced with the sugar; but I accept this suggestion cautiously, and hope to follow it out more carefully another summer.

As to the literature of the subject, properly speaking there is none, except that referred to previously; but it may be worth while to say something on the general subject of what I would call "symbiotic fermentation."

There can be little doubt that the idea here introduced is likely to bear fruit if pursued further. It has long been known that certain micro-organisms so act on particular nutritive substrata, that they prepare the latter, so to speak, for other organisms. The successive crops of bacteria in putrefaction, of yeast and mould, &c., in after-fermentations, are well-known cases in point. An excellent example is afforded by the grapes affected with *Edelfäule*, in some parts of the Rhine-lands. As MÜLLER-THURGAU has shown,* these grapes are rendered mouldy and "rotten" by a species of *Botrytis*, which so alters the constitution of the grapes that the proportion of acids, sugar, and nitrogenous matters are altered before they go into the must: such grapes yield wines of higher quality and finer "bouquet" than merely ripe healthy ones similarly fermented.

Again, PERDRIX† has recently isolated from water an interesting anaërobian bacillus which ferments starch into a glucose-like body; and finds that if a yeast is added to the cultures it completes the fermentation as an alcoholic fermentation.

In these and similar cases, however, we may regard the fermentations as not

* THIEL'S 'Landwirthsch. Jahrb.,' vol. 17, 1888, pp. 83-160.

† 'Annales de l'Institut Pasteur,' vol. 5, 1891, pp. 286-311.

symbiotic, but rather *metabiotic*, *i.e.*, the action of the one organism follows on that of the other.

Probably the distinction is not so real as it appears, but I think we must uphold it for the present at any rate; for there are compound fermentations where the actions go on more simultaneously.

For instance, GARRÉ, investigating certain phenomena of antagonism between bacteria,* found that two forms may grow side by side on the same medium, *e.g.*, nutritive gelatine, and carry on a symbiotic existence; whereas, in other cases, the one form ousts the other by poisoning the medium for it (*antibiosis*), or, in yet others, it renders the medium more favourable for a second form.

It seems extremely likely that the Kephir-ferment, which presents so many morphological resemblances to the Ginger-beer plant, also induces symbiotic fermentations, and I can conceive of no line of biological research more likely to yield results than this one.†

It has long been recognised that many of the "diseases" of beer, wine, &c., are due to mixed ferments, and it is almost certain that some of these carry on symbiotic life-actions, though many of the best-known "diseases" of beer are due to metabiotic and antibiotic fermentations; but I would draw the attention of brewer's technologists to another side of the question, *viz.*, that many of the best brews are known to be due to yeasts which are not of a pure strain, in HANSEN'S sense, and it is not at all improbable that a better brew can be obtained by symbiotic ferments than by a pure one.

In any case, it is a logical consequence of the study of the separate fermentations that the behaviour side-by-side of those which live symbiotically shall also be tested.

DESCRIPTION OF PLATES 11-16.

Yeast a.—*Saccharomyces pyriformis* (*n. sp.*).

PLATE 11, figs. 1-10.

Fig. 1. Characteristic groups of the yeast, obtained from a nine days' culture in 5 per cent. ginger solution (old) from Flask (4), of December 19, 1890. ZEISS, L/4.

* "Ueber Antagonisten unter den Bakterien" ('Correspondenzblatt f. Schweizer. Aerzte,' Jahrg. 17, 1887).

† With regard to Kephir, the first paper to consult is KERN, "Ueber ein neues Milch-ferment aus dem Kaukasus" ('Bullet. de la Soc. Imp. d. Nat. de Moscou,' 1881, and 'Bot. Zeitg.,' 1882). Further literature in DE BARY, 'Lectures on Bacteria' (Engl. Ed., 1887, p. 184), and in MIX, "On a Kephir-like Yeast found in the United States" ('Proc. of the Amer. Acad. of Arts and Science,' vol. 26, 1891, pp. 102-114). It should be noted that LEVY ('Deutsch. Med. Zeitung,' 1886, p. 783) says the ferment is not necessary.

- Fig. 2. A group of the above after treatment with a dilute solution of iodine in potassium iodide. The sienna colour pales to straw-yellow, or even disappears on warming, but returns on cooling—ERRERA'S glycogen reaction. ZEISS, L/4.
- Fig. 3. Two groups of the same yeast, the contents of which have become converted into two, three, or four spores. From tube 3c of December 19, 1890, after four days' culture on pure gelatine at a temperature of 22° C. The spores in the upper group (A) are quite ripe; those of the lower group (B) are not, having but just completed their development, as the thinner cell-walls indicate. ZEISS, L/4.
- Fig. 4. A continuous culture of one yeast-cell in a hanging-drop of old ginger gelatine. From Flask 4 α . On December 29, 1890, the cell was as shown at α at 4.30 P.M. (temp. = 15° C.). At 9 P.M., the temperature having risen to 15° C., a vigorous bud was developing as seen at β . At γ we have the condition of affairs next morning, December 30, at 11 A.M. (temp. = 12° C.); at 9 P.M., same day, two new buds were formed (temp. = 12° C.) as seen at δ ; and ϵ shows the rapidly developing colony at 10.30 A.M. on December 31 (temp. = 13° C.). Twenty-four hours later, the colony was easily visible to the unaided eye, being about 1 mm. in diameter. ZEISS, E/4, but drawn to a large scale.
- Fig. 5. A similar culture to the above, but in gelatine only (with traces of the saccharine solution). α , on January 3, 1891, at 11 A.M. (temp. = 14°·5 C.). β , on January 4, at 11 A.M. (temp. = 14° C.). γ , on January 5, at 10 A.M. (temp. = 11°·1). δ , on January 6, 10 A.M. ϵ a similar colony to δ , seen as an opaque object on the surface of the gelatine drop; such colonies are perfectly visible to the unaided eye, and can readily be used for the preparation of pure cultures. ZEISS, E/4, and drawn to scale.
- Fig. 6. Similar culture from an isolated cell in a drop of HAYDUCK'S gelatine-glucose, in which it was completely submerged. From Flask 4. On January 1, 1891, α = the cell at 1 P.M. (temp. = 19° C.); β , at 3 P.M. (temp. = 18° C.); γ , at 9 P.M. (temp. = 17° C.); δ , at 11 A.M., on January 2 (temp. = 16° C.); ϵ , at 3 P.M. same day (temp. = 19° C.). At 11 A.M., on January 4, the colony was too complex to draw, and, on January 5, it was clearly visible as a pure white spot, about 2 mm. diameter, and used for the preparation of flask cultures. ZEISS, D/4.
- Fig. 7. Two groups of old yeast-cells of this species, after lying for some months at the bottom of the flask. They are not dead, but the protoplasm undergoes a kind of fatty degeneration and the fat globules may present a resemblance to spores. Many of these cells germinate readily in fresh media, the oil-drops running together and disappearing before budding recommences.

Similar preparations are obtained in old hanging-drops of gelatine. ZEISS, E/4.

- Fig. 8. A characteristic group of the yeast cells from the aërobian films of old cultures (so-called "involution form"). The pyriform shape is very pronounced. ZEISS, J, occ. 4.
- Fig. 9. A group of the aërobian forms, from a fifty-two days' culture in beer-wort, kindly photographed for me by Dr. G. H. MORRIS, of Burton-on-Trent.
- Fig. 10. Germination of the yeast-spores in dilute Pasteur-asparagin, from specimens which had developed the spores on gelatine eleven months previously. The dry ripe spores are very brilliant and contracted (α). In forty-eight hours they have swollen considerably, and are less highly refractive (b), and during the next twenty-four hours begin to bud like the ordinary yeast-cells, either escaping from the mother-cell (c) or protruding the new bud through its cell-wall. ZEISS, J, imm., occ. 4.

Mycoderma cerevisiæ (DESM.).

PLATE 12, figs. 1-6.

- Fig. 1. Characteristic groups of *Mycoderma cerevisiæ*, as found growing on the top of the saccharine liquids in contact with plenty of air, well developed, and growing rapidly. From surface of sugar solution in soda-flask with G.B.P. in. It will be noticed that the direction and number of the branch cells determine the forms of the colonies. ZEISS, D/4.
- Fig. 2. Characteristic groups as found growing on a good medium, but with a limited supply of air. Specimens taken from a tube, on the surface of which it floats as a thin, flat, dull-grey, greasy film, twenty-four hours old. As shown at α , the cells each contain a minute brilliant dot, and vacuoles, when mature; this dot is very characteristic of the fungus. The dull appearance of the films is due to the air, which is entangled among the cells, and looks black under the microscope, as shown at b .
- Fig. 3. Groups characteristic of the submerged *Mycoderma*, as it hangs from the base of the thicker, rapidly growing, floating membranes, fall from them into the liquid. (From Flask 33, December 11, ZEISS, D.) c shows a form also often met with in the solutions. ZEISS, D/4.
- Fig. 4. Groups characteristic of starved *Mycoderma*, growing slowly on or in bad nutritive media. α was taken from a three weeks' culture in yeast-water, on the surface of which it floats in dull grey, thin, feebly growing islands, with air entangled. ZEISS, D/4. b was from a twenty-two days' culture on yeast-water gelatine. ZEISS, J/4.

- Fig. 5. Culture from a single cell in hanging-drop of HAYDUCK's gelatine-glucose. α the cell at 3 P.M., January 24 (temp. = 16° C.); β the same at 11 A.M. on January 25 (temp. = 14° C.); γ the colony at 9 A.M. on the 26th (temp. = 14.5° C.). Next day the colony was too large to draw. ZEISS, D/4.
- Fig. 6. Similar culture, but the cell completely immersed in glucose-ginger-gelatine, between a cover-slip and slide. The experiment was commenced on December 21 at 4 P.M. (temp. = 12° C.), but no growth occurred till the 23rd, when the cell began to bud at one end very slowly (temp. = 15°-16° C.), and on 25th the drawing *b* was made. *c* represents the state of affairs on the 26th at 10.30 A.M. (temp. = 18° C.), and *d* on the 27th. It should be noticed that the shrinkage and cracking of the gelatine let in air more and more as the culture progressed. ZEISS, C/4.

Rosy Yeast.

PLATE 12, figs 7-10.

- Fig. 7. A characteristic group of the yeast, as obtained from the pink film on PASTEUR'S solution. (Flasks 24, 26, 28, and 12.) December, 1890. ZEISS, D/4.
- Fig. 8. Groups of same, obtained by infecting beet solutions from Flask 3. The film was four days old; the original infecting material had remained in its flask from May 20, 1890, to March 14, 1891. ZEISS, D/4.
- Fig. 9. Three specimens of the above yeast, transferred from beet solution to a hanging-drop of beet gelatine. A, the three specimens at 3.30 P.M., March 14, 1891 (temp. = 12° C.); B, the same at 5 P.M. same day; C, at 10 A.M. next day.
- Fig. 10 (α -*q*). Successive stages in the development of a mycelium from a single cell (of Flask B 4), cultivated in a hanging drop of beet gelatine. The observations were started at 10.30 A.M. on March 15 (fig. α), temp. = 12° C.; growth began at once; *b* = 12.30, and *c* = 4 P.M.; *d* = March 16, at 9 A.M.; *e* = 6 P.M.; *f* = March 17, 10 A.M.; *g* = at 4 P.M.: the temperature had now risen to 15° C. At 9 A.M. on March 18 the mycelium was beginning to form, as seen at *h*, by the outgrowth of the cells into hyphæ (eventually septate), which bud off terminal conidia; *i* to *l* = stages in further development of the hypha, marked \times in *h*; *i* = at 12 noon on March 18; *k*, at 4 P.M.; *l*, at 9.30 on March 19; *m*, a group of conidia-bearing hyphæ, from the enlarging mycelium (March 20); *n*, one of the conidia which had fallen and germinated in the beet gelatine; *o*, large mycelium (March 21), due to the further development of *h*. The radiating hyphæ bear conidia (cf. *m*),

and two of these conidiophores are drawn at *p* and *q*. The pink hue, characteristic of the masses of "yeast," is also seen in the centre, where the hyphæ are most densely packed. α to *n*, and *p* and *q* = ZEISS, D/4; *o* = ZEISS, B/4.

Schizomycete No. 1.—*Bacterium vermiforme*, *n. sp.*

PLATES 13 and 14.

(Average sizes—rodlets, $1-5 \mu \times 0.5 \mu$; cocci, 0.5μ diam.)

- Fig. 1. Two specimens of the colonies obtained in pure cultures, in beet solution or in HAYDUCK'S solution. Magnified about 5 diameters.
- Fig. 2. One of the very small brain-like colonies in young cultures, magnified as an opaque object. It consists of closely convoluted sheathed filaments, with a brilliant lustre. Any of the smaller knobs on the masses in fig. 1 would present the same structure. ZEISS, D/4.
- Fig. 3. Specimens of loose filaments and bacilli, found floating about in the earlier stages of growth of the organism. Many of the bright vermiform bodies have bacillar rods or filaments in them, but the lustrous sheath prevents their being easily seen in the fresh state; some are devoid of contents, however, and many rodlets are free. ZEISS, D/4.
- Fig. 4. Four selected specimens of the above, to show the extraordinary coiling, &c., of the filaments round themselves. Such specimens are very common during the active early stages of the fermentation. ZEISS, D/4.
- Fig. 5. A similar group of empty sheaths: A, in the fresh state; B, after treatment with alcoholic iodine solution. The masses become shrivelled and granular. These, as also the sheaths in figs. 3 and 4, do not dissolve in freshly prepared ammoniacal cupric oxide, which at once dissolves cotton wool; they do not turn blue in chlor. zinc iodide, nor in iodine and sulphuric acid. KHO does not obviously dissolve them, though they swell in it. They remain for days and weeks intact in water, even when boiled in it; but they dissolve in strong sulphuric acid. ZEISS, D/4.
- Fig. 6. Specimens of the filaments, taken from a very active fermentation, and more highly magnified with strong transmitted light. Each of the vermiform bodies is now seen to be a filament, or row of rods, enveloped by a thick sheath, often corrugated. The average sizes are: length, 5μ to over 100μ ; breadth of sheath, 4.5μ to 5.5μ ; breadth of enclosed rodlets, filaments, &c., about 0.5μ , or a little more. Though the Schizomycete is often, perhaps mostly, in the axis of the sheath, this is by no means always the case, as the specimens *a* and *c* show. In *b*, the filament is escaping terminally from its sheath; in *c* it is throwing off the sheath laterally. Treatment with iodine

solution or with picric aniline blue brings out the same facts very clearly. ZEISS, L/4.

Fig. 7. Time records of the growth of one of the filaments, in a hanging drop of old ginger-gelatine. In this was placed traces of the Ginger-beer plant (yeasts and bacteria) on December 29, 1890, and the behaviour of one of the yeast-cells was traced up to the 31st of December. On that date I found that several of the Schizomycete filaments were also growing, and an isolated specimen was marked and its behaviour traced, with the following results— α , the filament at 9 A.M., December 31 (temp. = 15° C.); b , the same at 3 P.M., and c , at 9 P.M. on the same date (temp. 15° C.); d shows the state of affairs on January 1, 1891, at 11 A.M. (temp. 17° C.), and it is noticeable that a considerable intercalary growth, as well as terminal, has occurred; moreover, the growth throughout is confined to the right-handed portion of the coiled filament. At 3 P.M., on January 1, the drawing e was made (temp. = 19° C.), and at 9 P.M. the one marked f (temp. = 17° C.). Next morning, January 2, at 10.30, the coils had increased considerably, as seen at g (temp. = 16° C.), but the growth now slowed off, for the stage h was not reached till 11 A.M. on January 3 (temp. = 14.5), and although I watched the specimen till January 9, no further changes were observable. It will be seen that the corrugations in the sheath, first noticed at stage f , increased daily in the older portions of the filament.

It is uncertain which of the following phenomena accounts for the diminished growth and cessation at stage h . In the first place, the yeast colonies were increasing all the time, and eventually (January 9) were invading the neighbourhood of the filament; this must have entailed an accumulation of carbon dioxide, and diminution of the oxygen, and at first I attributed the cessation to these causes, but this is irreconcilable with the behaviour of the Ginger-beer plant in corked bottles and in sealed tubes under pressure and *in vacuo*.

It is much more probable that the diminution in temperature from January 9 onwards was responsible for the stoppage of growth. I recorded the temperature each morning as usual when observing the cultures, and append the numbers for the period in question:—

	° C.
10 A.M., January 5	= 11.5
10 „ „	6 = 8.5
3 P.M. „	6 = 11.5
10 A.M. „	7 = 9.0
10 „ „	8 = 11.0
10 „ „	9 = 12.0
12 noon „	10 = 10.0

Of course it must also be remembered that the nutritive materials in the hanging-drop were being exhausted, and that the products of action of the yeasts and Schizomycete were accumulating.

Fig. 8. Types of the Schizomycete from a pure culture in HAYDUCK'S solution, March 29. Some of the forms are coiled as before, but others are short rodlets symmetrically or excentrically immersed in the gelatinous sheaths. Others, again, are free and unsheathed rodlets, some so short as to be mere cocci. ZEISS E, occ. 4.

PLATE 14.

Fig. 1. Various stages in the development of the gelatinous sheathing substance by a rodlet observed in a hanging-drop of bouillon-Pasteur, stiffened with gelatine. The drop was infected with organisms from a marked tube, August 14, at 10 A.M.; on the 15th the development had begun. *a* = a coiled sheath with the rodlet at the left end, at 4 P.M. (August 15); *b* the condition of affairs at 9 P.M. same day—the rodlet has advanced considerably to the left, and begun to return across its path, the latter being indicated by the gelatinous substance found. *c* = 7 A.M., August 16; a new loop had been formed during the night, and the erratic rodlet is forming another, but does not complete it (*d* = 1 P.M., and *e* = 7 P.M., August 16). On August 17 another loop is formed (*f* = 9 A.M., August 17), and during the next twenty-four hours a series of coils and loops are completed (*g* = 9.30 A.M., August 18). No further changes occurred, though the specimen was watched till August 27. ZEISS, D, occ. 4.

Fig. 2. Stages in the behaviour of the small sheathed rodlets, observed in a hanging-drop of beet-gelatine, May, 1891 (from a marked tube). At 10 A.M. on May 29, temp. = 17° C., the two rodlets shown at *a* were fixed and drawn. At 12 noon of same date the sheathed one had changed its position, as shown at *b*, and had added to its sheath; the free rodlet remained unaltered (temp. = 20° C.). *c* shows the further growth of the sheath of the former at 4 P.M. of same date, and a slight sheath now invests the other rodlet, the temperature having again fallen to 17° C. Next morning, at 10 A.M. (temp. = 13° C.), the first one had added considerably to its sheath, and the free rodlet had now a very evident swollen sheath, the rodlet lying at one end (*d*); at 4 P.M., same date, the first sheath had grown yet larger, and the second rodlet had escaped bodily from its (also slightly more voluminous) sheath. Temp. = 13° C. No further changes could be observed. ZEISS, D, occ. 4.

Fig. 3. Changes observed in Pasteur-bouillon (equal volumes) stiffened with gelatine, and in an atmosphere of carbon dioxide. The preparation was made from a

fourth day's culture of the Ginger-beer plant, in PASTEUR'S solution, in a soda-water flask (B). At 4.30 P.M. on September 1 the yeast-cell and a neighbouring row of rodlets, in sheath, were fixed (fig. 3, α). At 10 A.M., September 2, the rodlets were growing and dividing in the sheath (b). This went on, and on September 3, 9 A.M., the right-hand longer rodlet had begun to break up into bacteria (c), which had next day divided again into cocci. The yeast-cell remained quiescent throughout. ZEISS, D, occ. 4.

- Fig. 4. Curious branching of the sheathing matrix by the repeated growth and division of the peripherally situated Schizomycete. From an eight days' fermentation in Pasteur-bouillon-gelatine, a culture was made in a drop of ginger-gelatine on September 9; several yeast-cells were present in the drop. The specimen α was fixed under the microscope at 10 A.M.; at 4 P.M. (b) the rodlets marked \times , $\times\times$, and $\times\times\times$ had divided, separated, and advanced laterally to the left, adding to the gelatinous matrix as they did so, similarly with those on the right. c shows the condition of affairs next morning at 10 o'clock. No further changes were traced. ZEISS, D, occ. 4.
- Fig. 5. Changes induced in a sheathed filament when transferred from one medium to another. The specimen was from a four days' fermentation in normal PASTEUR'S solution and ginger. On September 1 it was transferred to a drop of PASTEUR'S solution, to which Pasteur-bouillon-gelatine was added. Fig. α was sketched at 9.30 A.M. on September 2; b , at 2.30 P.M., same date, its sheath is swelling and peeling off, as it were. $c = 9$ A.M., September 3, the swelling has increased, and produced contortions of the filament, the growth of which is scarcely noticeable. $d = 9.30$ A.M., September 4, the swelling and wrinkling of the sheath have increased. Nothing occurred further except a slight increase of the swellings on the right hand, although the specimen was watched till September 7. ZEISS, E, occ. 4.
- Fig. 6. Division of the motile bacterial form in a drop of bouillon-gelatine-sugar. α at 10 A.M.; β at 4 P.M.; c at 7 A.M. next day; d at 2 P.M.; and e at 5 P.M.; f on the third day. The division was very slow, apparently owing to the gelatine. The final result was the formation of cocci, which remained unchanged in the matrix. ZEISS, E, occ. 4.
- Fig. 7. Two of the filamentous forms of *Bacterium vermiforme*, in a hanging-drop of bouillon-gelatine-sugar, and breaking up into segments, then shorter and shorter rodlets, and finally cocci. ZEISS, E, occ. 4.
- Fig. 8. Typical group of the swarming filaments and rodlets, breaking up into cocci, from a culture in bouillon; drawn after staining with methyl-violet, as seen under SWIFT'S $\frac{1}{2}$ -in. apochromatic oil-immersion.
- Fig. 9. Type of a fifteen days' synthetic culture of the *B. vermiforme* together with *Saccharomyces pyriformis*, in bouillon-glucose. The yeast is budding

freely. The Schizomycete grows out into long filaments, which then break up into the swarming rods of various lengths. ZEISS, E, occ. 4.

Fig. 10. Type of a fifteen days' synthetic culture of the yeast and bacterium in bouillon only. The yeast buds slowly and for a short time only. The Schizomycete grows out into filaments, which rapidly break up into very short rodlets (bacteria) and cocci. ZEISS, E, occ. 4.

Fig. 11. Type of a fifteen days' synthetic culture of the yeast and bacterium together in a suitable saccharine medium (Pasteur-bouillon). The filaments and rodlets ensheath themselves as soon as the carbon dioxide is in excess, and entangle the well-developed yeast-cells in the coils of the gelatinous matrix. The mass becomes denser and denser, and at last forms the hard brain-like lumps of the Ginger-beer plant, so like those figured at Plate 13, fig. 1, that it was unnecessary to draw special figures of them. ZEISS, E, occ. 4.

Schizomycete No. 2.—Ginger-bacillus.

PLATE 15, figs. 1-6.

Fig. 1. Two characteristic groups of the bacillus in the filamentous condition, as found on the surface of glucose solution forty hours after immersion of a piece of ginger. January 5, 1891. ZEISS, E/4. In B, many of the filaments run parallel, and show septa; in A, some are breaking up.

Fig. 2. Bacillar rods obtained by twenty-four hours' culture of above filaments on gelatine. The filaments simply disjoint into rods, which then swarm. Some of the longer rods are still disjointing. ZEISS, E/4.

Fig. 3. A mass of spores obtained from the above culture forty hours later than last phase. All the filaments and rods at the top of the liquefied gelatine have formed spores thus: below the surface they are still breaking up, as in fig. 1, A, and fig. 2. These spores are embedded in an indistinguishable matrix. ZEISS, E/4.

Fig. 4. Two groups of spores and spore-forming segments, more highly magnified (ZEISS, L/4). A from the original culture in glucose, on the fifth day; B from the group shown in fig. 3 (under a lower power) and stained with iodine.

Fig. 5. A. Group of the spores of figs. 3 and 4 sown in a hanging-drop of PETER'S gelatine at 4 P.M. on January 10, and placed in the incubator at 27° C. B. Bacilli developed from the spores at 9 P.M., January 11. C. Bacilli and filaments which are segmenting, at 10 P.M. next day. D. Spore-forming segments in same culture. All ZEISS, E/4.

Fig. 6. Germination of the spores. α = a sowing of the ripe spores in gelatine-glucose made on March 30, and kept at 28°-30° C. On the 31st, at 10 A.M.,

they had swollen, and several of them were germinating (fig. 6, β) into bacillar rods. (SWIFT $\frac{1}{2}$ homogeneous oil immersion.)

Schizomycete No. 3.—Bacterium aceti (KÜTZ.).

PLATE 15, figs. 7–9.

- Fig. 7. Two groups of the normal *Bacterium aceti*, obtained from a strong “Vinegar-plant,” grown on acidified claret and water. ZEISS, E, occ. 4.
- Fig. 8. Two groups of *Bacterium aceti* from the top of a tube-culture of the “Ginger-beer plant” with free access of atmospheric oxygen. ZEISS, J, imm., occ. 4.
- Fig. 9. A group of “involution forms” of *Bacterium aceti*, obtained from the film of an old culture of the Ginger-beer plant. ZEISS, J, occ. 4.

Oidium lactis (FRESEN.).

PLATE 15, figs. 12 and 13.

- Fig. 12. Characteristic group of the yeast-like form as found on the surface of flask 18. December 13, 1889. ZEISS, E/4.
- Fig. 13. Culture from a single cell isolated in a hanging-drop of peptone-gelatine. α , the cell at 10 A.M. on November 7th, 1889; β , 9 P.M. same day; γ , 9 A.M. next morning; δ , part of the mycelium twenty-four hours later; it is becoming disjointed into the yeast-like segments of fig. 1. ZEISS, D/4. (Temp. 14°–15° C. throughout.)

Dematium pullulans (DE BARY).

PLATE 15, fig. 14, and PLATE 16.

- Fig. 14. A, a characteristic group of the cells and mycelium as found on the boiled Ginger-beer plant, and placed in ginger-gelatine in a hanging-drop on February 14. The segment α was marked (2 P.M.) and watched; b , the above segment at 10 A.M. next day; c , the same at 10 A.M. on the 16th; $d-f$, and at x , similar series traced for other segments. (Temp. 14°–15° C.) ZEISS, D/2 and D/4.

PLATE 16.

Fig. 1. Culture from a single segment, isolated in a hanging-drop of HAY-DUCK'S glucose-gelatine, on February 14; *a*, at 4 P.M.; *b*, 10.30 A.M. on 15th (temp. = 17° C.); *c*, at 2 P.M. same day; *d*, at 8 P.M. same day; *e*, at 10 A.M. on February 16th. The brown colour pales somewhat, and the oil-drops gradually enlarge and run together as growth commences. The buds, when fully formed, fall into the drop and remain unaltered, unless transferred to fresh pabulum. All the above, ZEISS, D/4. *f*, the mycelium at 10.30 A.M. on February 17th, showing the copious development of buds now going on, and much less highly magnified (ZEISS, B/4). *g*, a small piece of a pullulating hypha, to the same scale as before (D/4): *h-l*, time drawings, showing the development of one of the buds; *h* at 10.50 A.M., *i*, at 11.30, *k* at 12.30, and *l*, at 1.15 P.M. ZEISS, J/4.

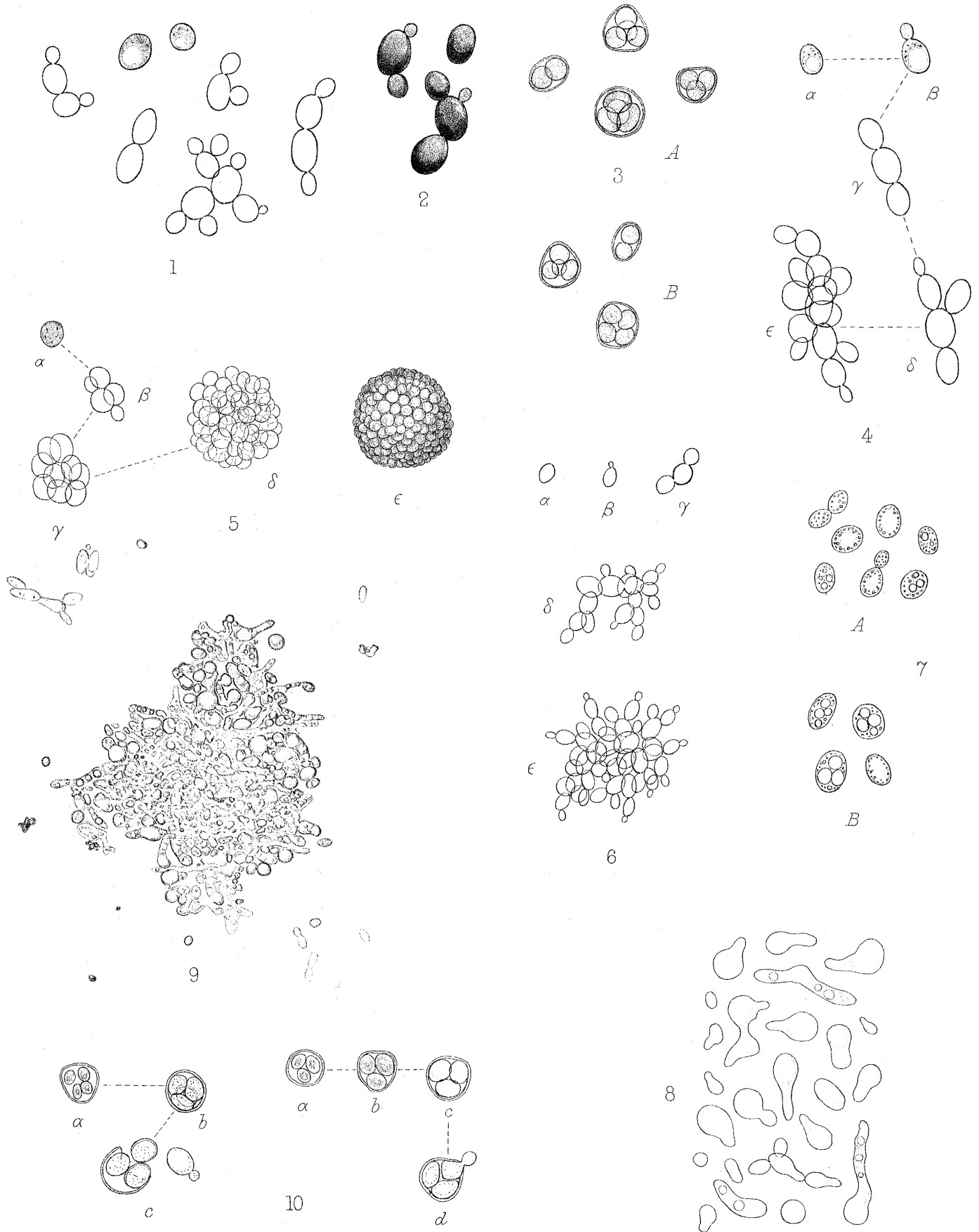

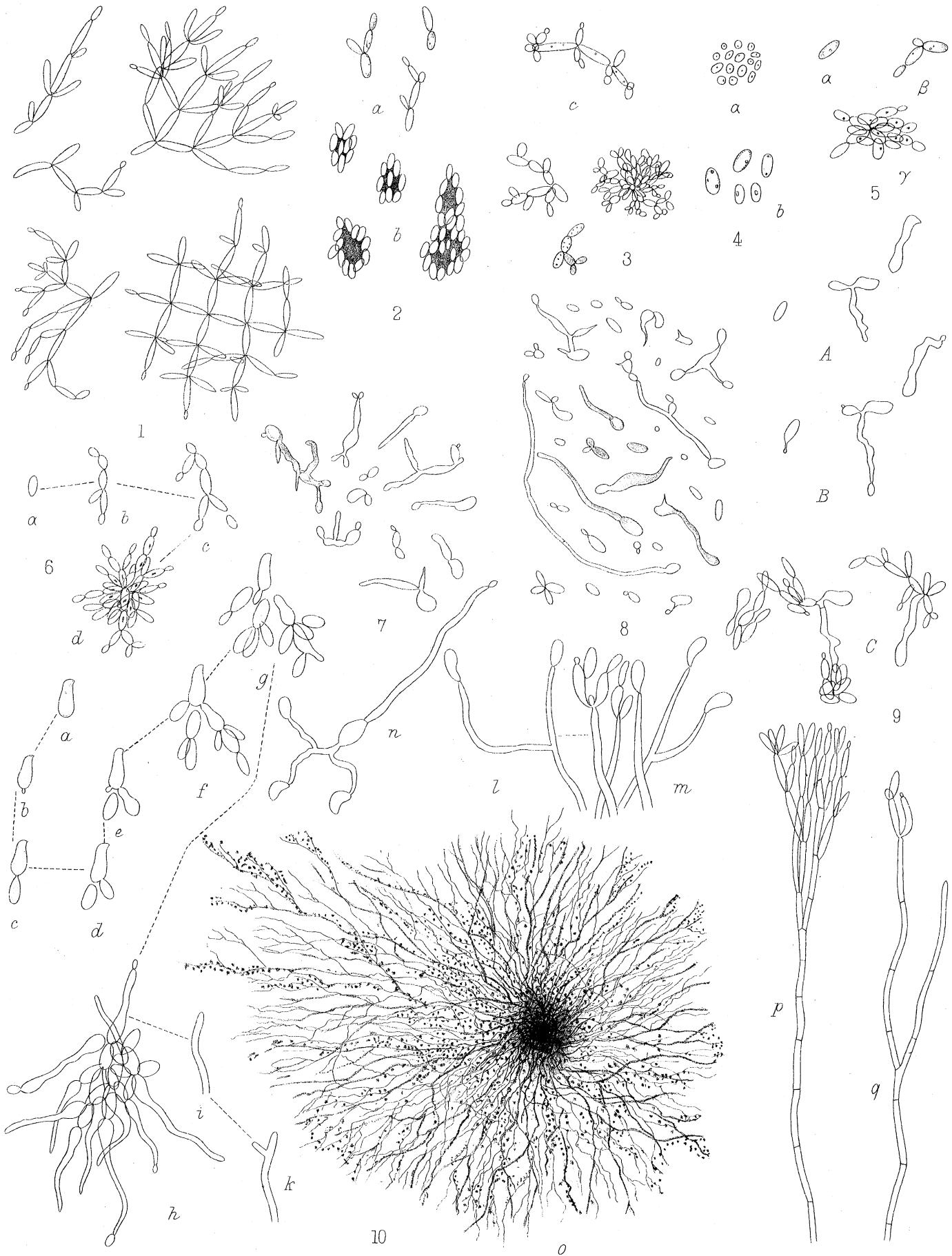



1

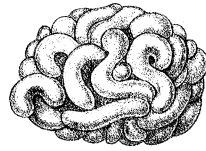

2

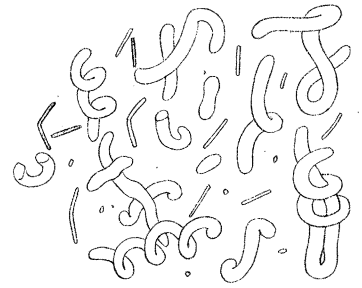

3

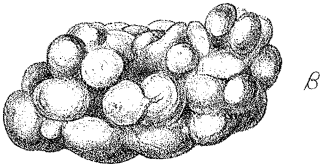

B

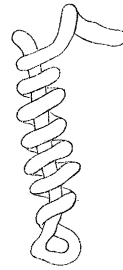

4

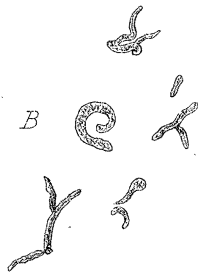
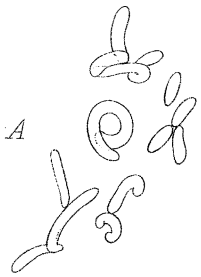

5

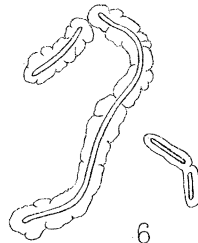

6

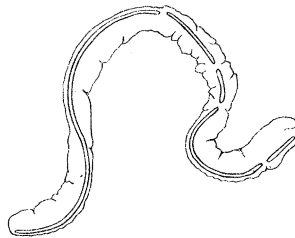

alpha

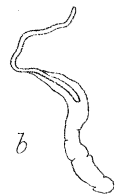

b

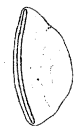

c

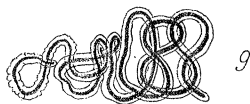

g

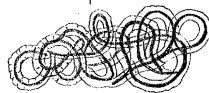

h

7

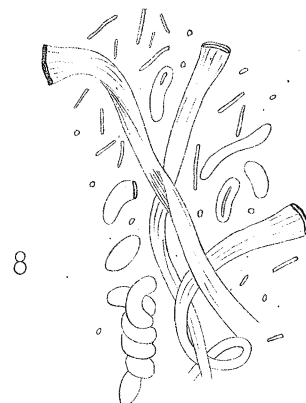

8

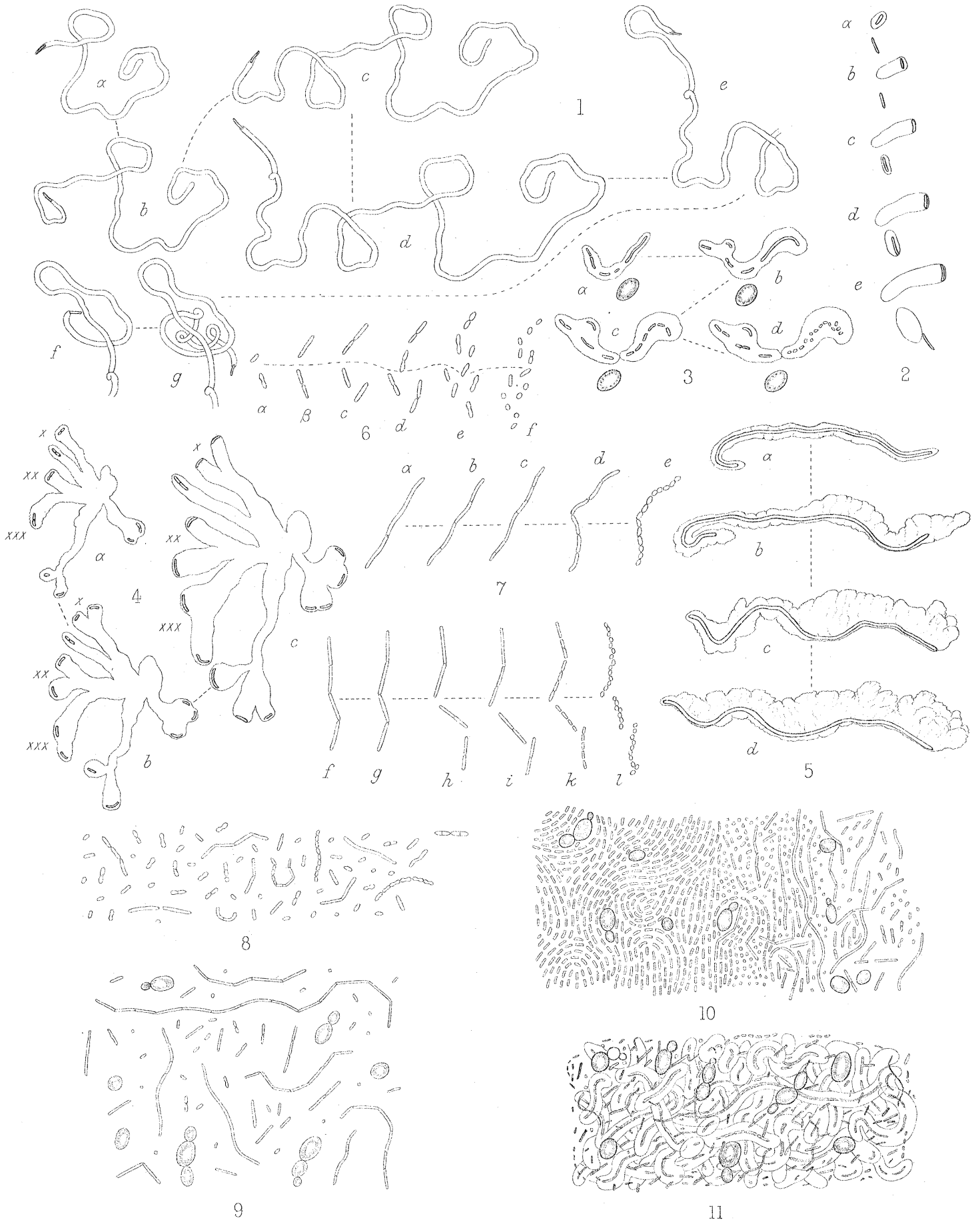

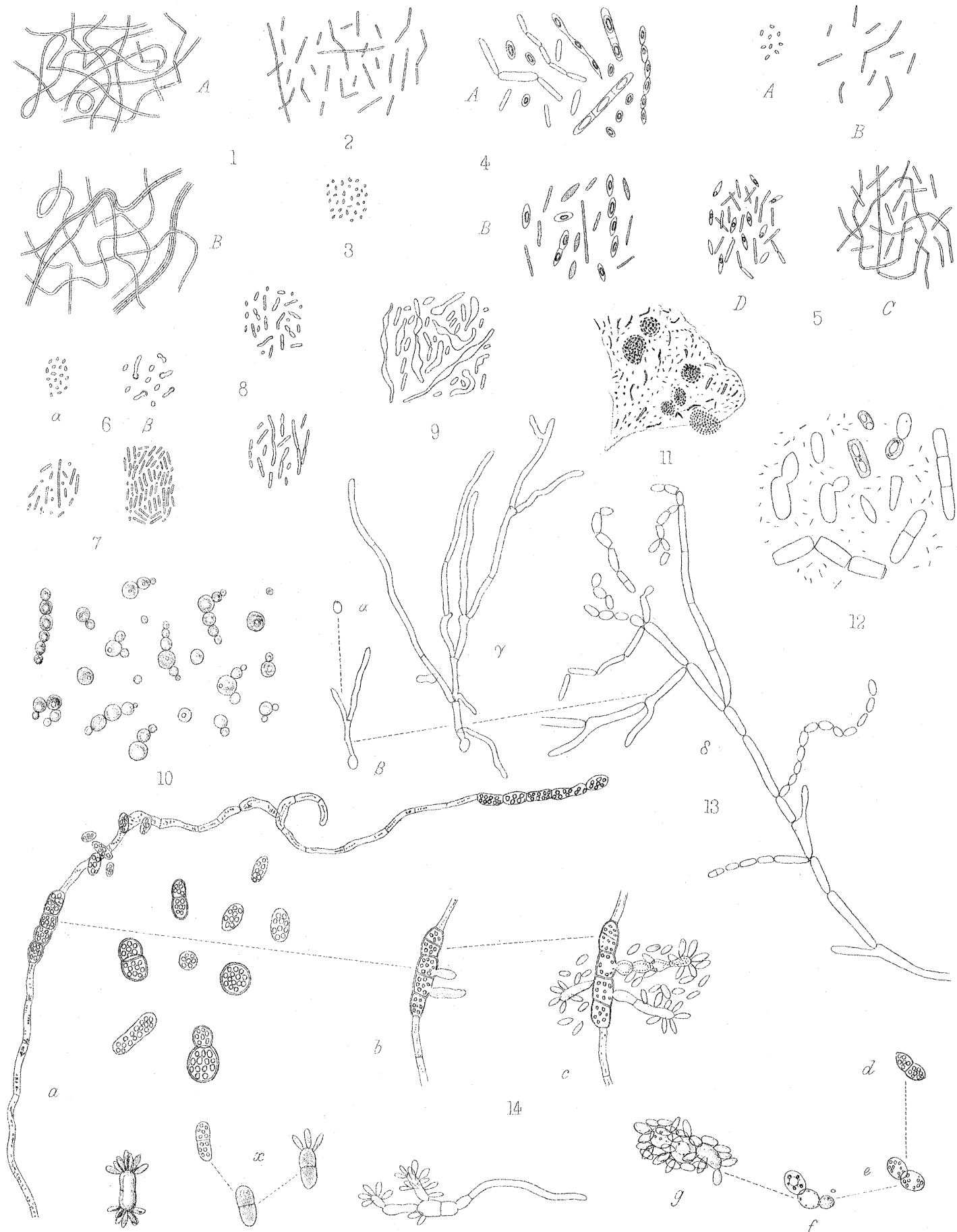

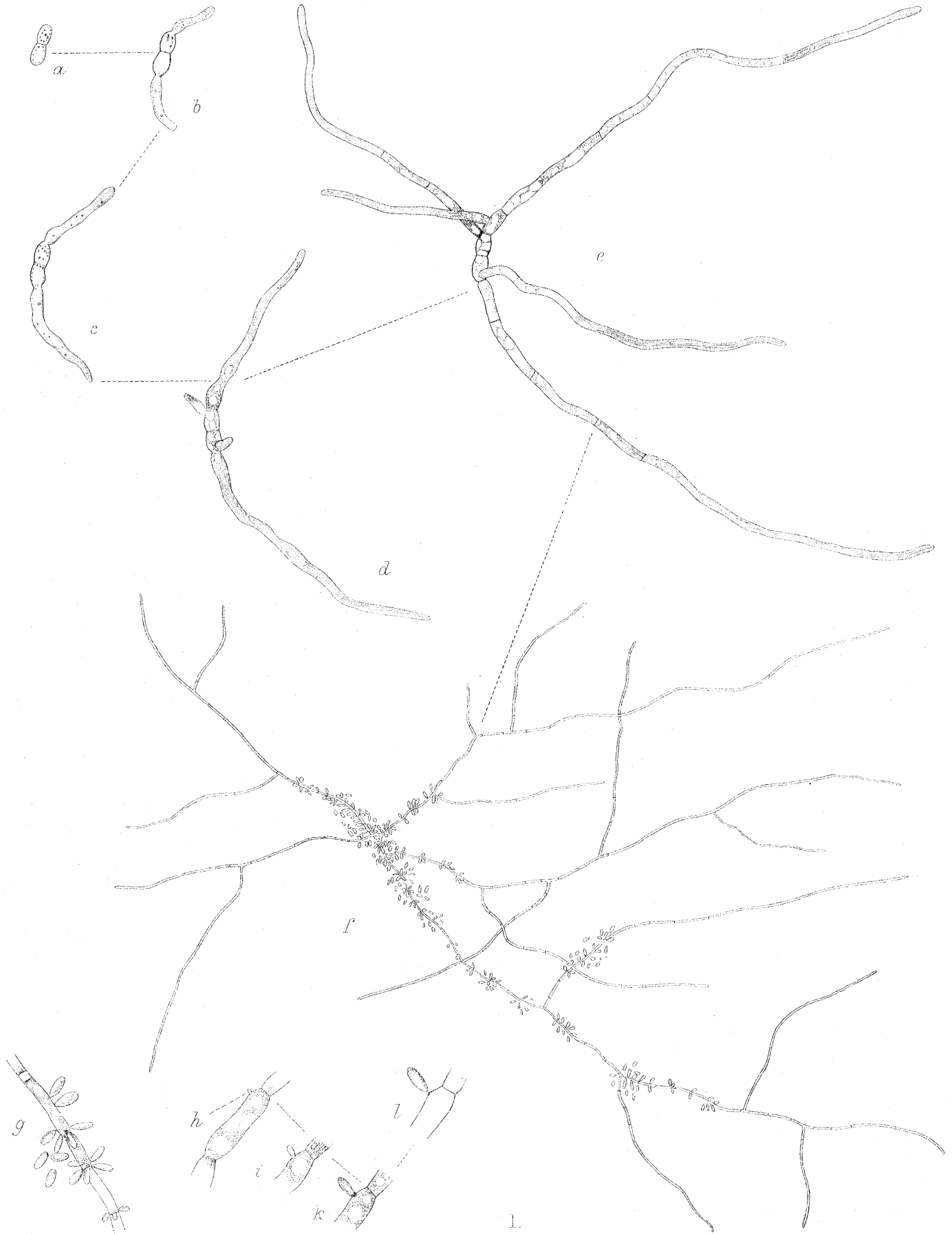

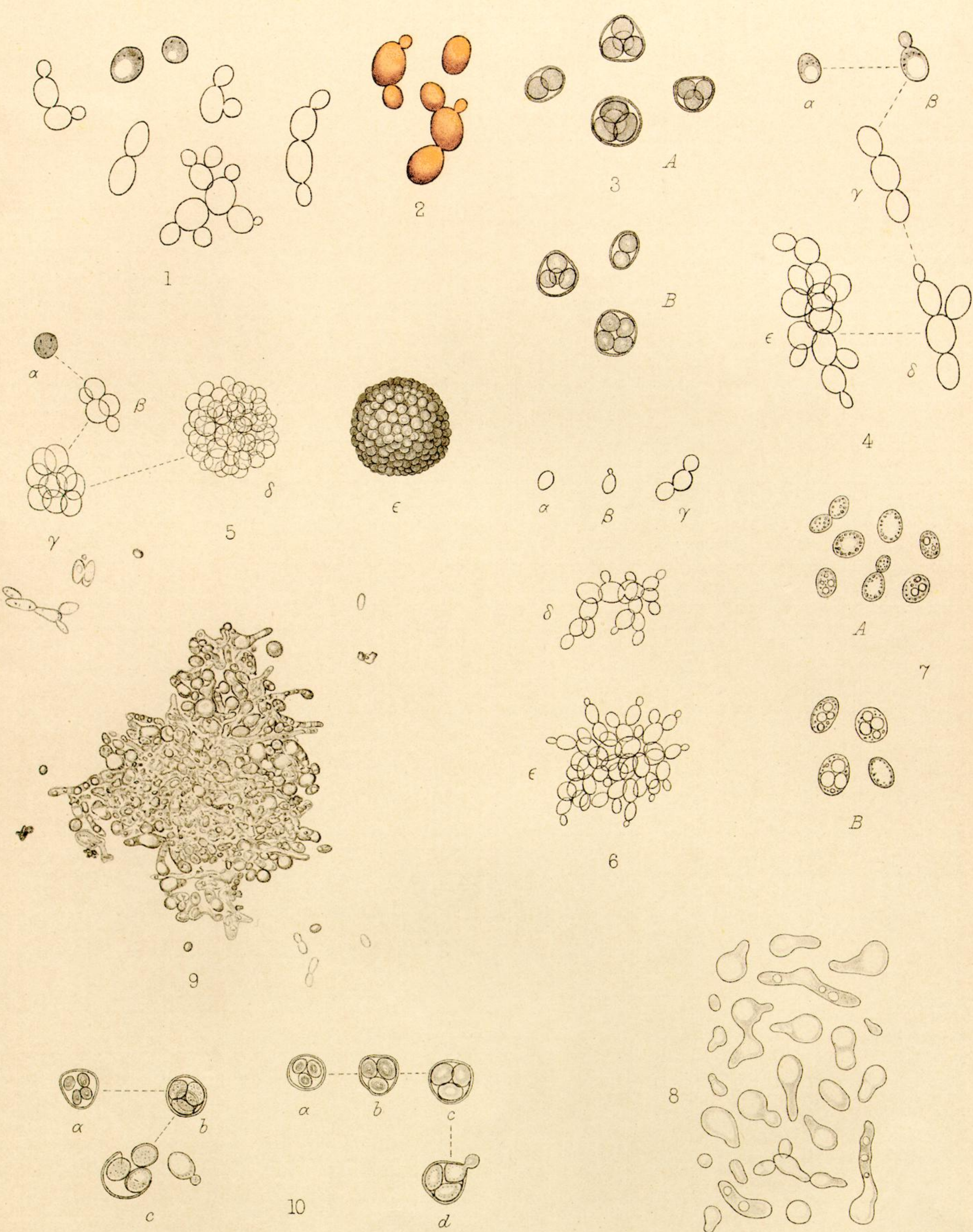

PLATE 11, figs. 1-10.

Fig. 1. Characteristic groups of the yeast, obtained from a nine days' culture in 5 per cent. ginger solution (old) from Flask (4), of December 19, 1890. ZEISS, L/4.

Fig. 2. A group of the above after treatment with a dilute solution of iodine in potassium iodide. The sienna colour pales to straw-yellow, or even disappears on warming, but returns on cooling—ERRERA'S glycogen reaction. ZEISS, L/4.

Fig. 3. Two groups of the same yeast, the contents of which have become converted into two, three, or four spores. From tube 3c of December 19, 1890, after four days' culture on pure gelatine at a temperature of 22° C. The spores in the upper group (A) are quite ripe; those of the lower group (B) are not, having but just completed their development, as the thinner cell-walls indicate. ZEISS, L/4.

Fig. 4. A continuous culture of one yeast-cell in a hanging-drop of old ginger gelatine. From Flask 4a. On December 29, 1890, the cell was as shown at α at 4.30 P.M. (temp. = 15° C.). At 9 P.M., the temperature having risen to 15° C., a vigorous bud was developing as seen at β . At γ we have the condition of affairs next morning, December 30, at 11 A.M. (temp. = 12° C.); at 9 P.M., same day, two new buds were formed (temp. = 12° C.) as seen at δ ; and ϵ shows the rapidly developing colony at 10.30 A.M. on December 31 (temp. = 13° C.). Twenty-four hours later, the colony was easily visible to the unaided eye, being about 1 mm. in diameter. ZEISS, E/4, but drawn to a large scale.

Fig. 5. A similar culture to the above, but in gelatine only (with traces of the saccharine solution). α , on January 3, 1891, at 11 A.M. (temp. = 14°·5 C.). β , on January 4, at 11 A.M. (temp. = 14° C.). γ , on January 5, at 10 A.M. (temp. = 11°·1). δ , on January 6, 10 A.M. ϵ a similar colony to δ , seen as an opaque object on the surface of the gelatine drop; such colonies are perfectly visible to the unaided eye, and can readily be used for the preparation of pure cultures. ZEISS, E/4, and drawn to scale.

Fig. 6. Similar culture from an isolated cell in a drop of HAYDUCK'S gelatine-glucose, in which it was completely submerged. From Flask 4. On January 1, 1891, α = the cell at 1 P.M. (temp. = 19° C.); β , at 3 P.M. (temp. = 18° C.); γ , at 9 P.M. (temp. = 17° C.); δ , at 11 A.M., on January 2 (temp. = 16° C.); ϵ , at 3 P.M. same day (temp. = 19° C.). At 11 A.M., on January 4, the colony was too complex to draw, and, on January 5, it was clearly visible as a pure white spot, about 2 mm. diameter, and used for the preparation of flask cultures. ZEISS, D/4.

Fig. 7. Two groups of old yeast-cells of this species, after lying for some months at the bottom of the flask. They are not dead, but the protoplasm undergoes a kind of fatty degeneration and the fat globules may present a resemblance to spores. Many of these cells germinate readily in fresh media, the oil-drops running together and disappearing before budding recommences. Similar preparations are obtained in old hanging-drops of gelatine. ZEISS, E/4.

Fig. 8. A characteristic group of the yeast cells from the aërobian films of old cultures (so-called "involution form"). The pyriform shape is very pronounced. ZEISS, J, occ. 4.

Fig. 9. A group of the aërobian forms, from a fifty-two days' culture in beer-wort, kindly photographed for me by Dr. G. H. MORRIS, of Burton-on-Trent.

Fig. 10. Germination of the yeast-spores in dilute Pasteur-asparagin, from specimens which had developed the spores on gelatine eleven months previously. The dry ripe spores are very brilliant and contracted (α). In forty-eight hours they have swollen considerably, and are less highly refractive (β), and during the next twenty-four hours begin to bud like the ordinary yeast-cells, either escaping from the mother-cell (γ) or protruding the new bud through its cell-wall. ZEISS, J, imm., occ. 4.



Mycoderma cerevisiae (DESM.).

PLATE 12, figs. 1-6.

- Fig. 1. Characteristic groups of *Mycoderma cerevisiae*, as found growing on the top of the saccharine liquids in contact with plenty of air, well developed, and growing rapidly. From surface of sugar solution in soda-flask with G.B.P. in. It will be noticed that the direction and number of the branch cells determine the forms of the colonies. ZEISS, D/4.
- Fig. 2. Characteristic groups as found growing on a good medium, but with a limited supply of air. Specimens taken from a tube, on the surface of which it floats as a thin, flat, dull-grey, greasy film, twenty-four hours old. As shown at *a*, the cells each contain a minute brilliant dot, and vacuoles, when mature; this dot is very characteristic of the fungus. The dull appearance of the films is due to the air, which is entangled among the cells, and looks black under the microscope, as shown at *b*.
- Fig. 3. Groups characteristic of the submerged *Mycoderma*, as it hangs from the base of the thicker, rapidly growing, floating membranes, fall from them into the liquid. (From Flask 33, December 11, ZEISS, D.) *c* shows a form also often met with in the solutions. ZEISS, D/4.
- Fig. 4. Groups characteristic of starved *Mycoderma*, growing slowly on or in bad nutritive media. *a* was taken from a three weeks' culture in yeast-water, on the surface of which it floats in dull grey, thin, feebly growing islands, with air entangled. ZEISS, D/4. *b* was from a twenty-two days' culture on yeast-water gelatine. ZEISS, J/4.
- Fig. 5. Culture from a single cell in hanging-drop of HAYDUCK's gelatine-glucose. *a* the cell at 3 P.M., January 24 (temp. = 16° C.); *β* the same at 11 A.M. on January 25 (temp. = 14° C.); *γ* the colony at 9 A.M. on the 26th (temp. = 14.5° C.). Next day the colony was too large to draw. ZEISS, D/4.
- Fig. 6. Similar culture, but the cell completely immersed in glucose-ginger-gelatine, between a cover-slip and slide. The experiment was commenced on December 21 at 4 P.M. (temp. = 12° C.), but no growth occurred till the 23rd, when the cell began to bud at one end very slowly (temp. = 15°-16° C.), and on 25th the drawing *b* was made. *c* represents the state of affairs on the 26th at 10.30 A.M. (temp. = 18° C.), and *d* on the 27th. It should be noticed that the shrinkage and cracking of the gelatine let in air more and more as the culture progressed. ZEISS, C/4.

Rosy Yeast.

PLATE 12, figs 7-10.

- Fig. 7. A characteristic group of the yeast, as obtained from the pink film on PASTEUR'S solution. (Flasks 24, 26, 28, and 12.) December, 1890. ZEISS, D/4.
- Fig. 8. Groups of same, obtained by infecting beet solutions from Flask 3. The film was four days old; the original infecting material had remained in its flask from May 20, 1890, to March 14, 1891. ZEISS, D/4.
- Fig. 9. Three specimens of the above yeast, transferred from beet solution to a hanging-drop of beet gelatine. A, the three specimens at 3.30 P.M., March 14, 1891 (temp. = 12° C.); B, the same at 5 P.M. same day; C, at 10 A.M. next day.
- Fig. 10 (*a-q*). Successive stages in the development of a mycelium from a single cell (of Flask B 4), cultivated in a hanging drop of beet gelatine. The observations were started at 10.30 A.M. on March 15 (fig. *a*), temp. = 12° C.; growth began at once; *b* = 12.30, and *c* = 4 P.M.; *d* = March 16, at 9 A.M.; *e* = 6 P.M.; *f* = March 17, 10 A.M.; *g* = at 4 P.M.: the temperature had now risen to 15° C. At 9 A.M. on March 18 the mycelium was beginning to form, as seen at *h*, by the outgrowth of the cells into hyphæ (eventually septate), which bud off terminal conidia; *i* to *l* = stages in further development of the hypha, marked × in *h*; *i* = at 12 noon on March 18; *k*, at 4 P.M.; *l*, at 9.30 on March 19; *m*, a group of conidia-bearing hyphæ, from the enlarging mycelium (March 20); *n*, one of the conidia which had fallen and germinated in the beet gelatine; *o*, large mycelium (March 21), due to the further development of *h*. The radiating hyphæ bear conidia (cf. *m*), and two of these conidiophores are drawn at *p* and *q*. The pink hue, characteristic of the masses of "yeast," is also seen in the centre, where the hyphæ are most densely packed. *a* to *n*, and *p* and *q* = ZEISS, D/4; *o* = ZEISS, B/4.

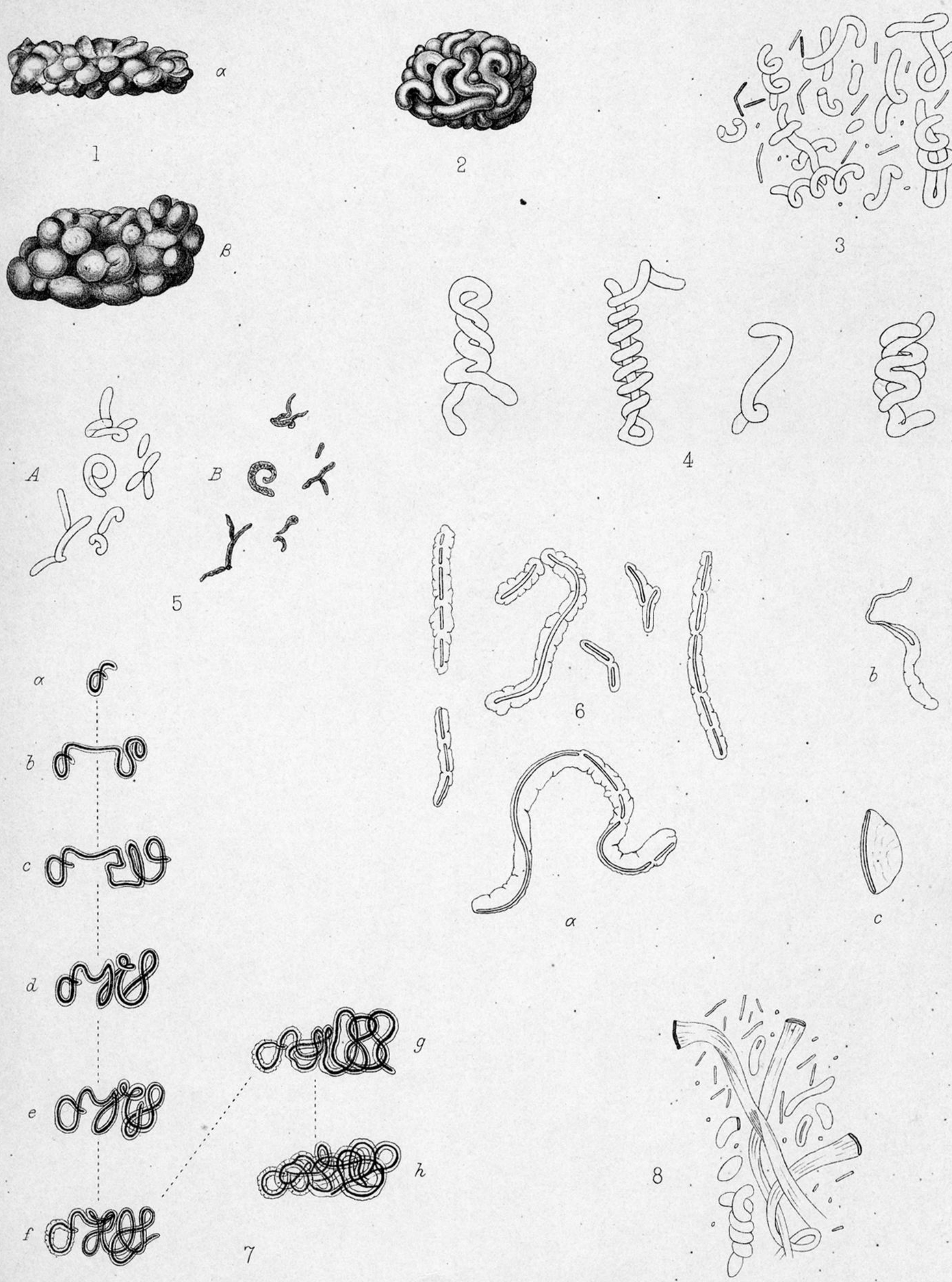

Fig. 1. Two specimens of the colonies obtained in pure cultures, in beet solution or in HAYDUCK'S solution. Magnified about 5 diameters.

Fig. 2. One of the very small brain-like colonies in young cultures, magnified as an opaque object. It consists of closely convoluted sheathed filaments, with a brilliant lustre. Any of the smaller knobs on the masses in fig. 1 would present the same structure. ZEISS, D/4.

Fig. 3. Specimens of loose filaments and bacilli, found floating about in the earlier stages of growth of the organism. Many of the bright vermiform bodies have bacillar rods or filaments in them, but the lustrous sheath prevents their being easily seen in the fresh state; some are devoid of contents, however, and many rodlets are free. ZEISS, D/4.

Fig. 4. Four selected specimens of the above, to show the extraordinary coiling, &c., of the filaments round themselves. Such specimens are very common during the active early stages of the fermentation. ZEISS, D/4.

Fig. 5. A similar group of empty sheaths: A, in the fresh state; B, after treatment with alcoholic iodine solution. The masses become shrivelled and granular. These, as also the sheaths in figs. 3 and 4, do not dissolve in freshly prepared ammoniacal cupric oxide, which at once dissolves cotton wool; they do not turn blue in chlor. zinc iodide, nor in iodine and sulphuric acid. KHO does not obviously dissolve them, though they swell in it. They remain for days and weeks intact in water, even when boiled in it; but they dissolve in strong sulphuric acid. ZEISS, D/4.

Fig. 6. Specimens of the filaments, taken from a very active fermentation, and more highly magnified with strong transmitted light. Each of the vermiform bodies is now seen to be a filament, or row of rods, enveloped by a thick sheath, often corrugated. The average sizes are: length, 5μ to over 100μ ; breadth of sheath, 4.5μ to 5.5μ ; breadth of enclosed rodlets, filaments, &c., about 0.5μ , or a little more. Though the Schizomycete is often, perhaps mostly, in the axis of the sheath, this is by no means always the case, as the specimens *a* and *c* show. In *b*, the filament is escaping terminally from its sheath; in *c* it is throwing off the sheath laterally. Treatment with iodine solution or with picric aniline blue brings out the same facts very clearly. ZEISS, L/4.

Fig. 7. Time records of the growth of one of the filaments, in a hanging drop of old ginger-gelatine. In this was placed traces of the Ginger-beer plant (yeasts and bacteria) on December 29, 1890, and the behaviour of one of the yeast-cells was traced up to the 31st of December. On that date I found that several of the Schizomycete filaments were also growing, and an isolated specimen was marked and its behaviour traced, with the following results—*a*, the filament at 9 A.M., December 31 (temp. = 15° C.); *b*, the same at 3 P.M., and *c*, at 9 P.M. on the same date (temp. 15° C.); *d* shows the state of affairs on January 1, 1891, at 11 A.M. (temp. 17° C.), and it is noticeable that a considerable intercalary growth, as well as terminal, has occurred; moreover, the growth throughout is confined to the right-handed portion of the coiled filament. At 3 P.M., on January 1, the drawing *e* was made (temp. = 19° C.), and at 9 P.M. the one marked *f* (temp. = 17° C.). Next morning, January 2, at 10.30, the coils had increased considerably, as seen at *g* (temp. = 16° C.), but the growth now slowed off, for the stage *h* was not reached till 11 A.M. on January 3 (temp. = 14.5), and although I watched the specimen till January 9, no further changes were observable. It will be seen that the corrugations in the sheath, first noticed at stage *f*, increased daily in the older portions of the filament.

It is uncertain which of the following phenomena accounts for the diminished growth and cessation at stage *h*. In the first place, the yeast colonies were increasing all the time, and eventually (January 9) were invading the neighbourhood of the filament; this must have entailed an accumulation of carbon dioxide, and diminution of the oxygen, and at first I attributed the cessation to these causes, but this is irreconcilable with the behaviour of the Ginger-beer plant in corked bottles and in sealed tubes under pressure and *in vacuo*.

It is much more probable that the diminution in temperature from January 9 onwards was responsible for the stoppage of growth. I recorded the temperature each morning as usual when observing the cultures, and append the numbers for the period in question:—

		° C.
10 A.M.,	January 5	= 11.5
10 "	"	6 = 8.5
3 P.M.	"	6 = 11.5
10 A.M.	"	7 = 9.0
10 "	"	8 = 11.0
10 "	"	9 = 12.0
12 noon	"	10 = 10.0

Of course it must also be remembered that the nutritive materials in the hanging-drop were being exhausted, and that the products of action of the yeasts and Schizomycete were accumulating.

Fig. 8. Types of the Schizomycete from a pure culture in HAYDUCK'S solution, March 29. Some of the forms are coiled as before, but others are short rodlets symmetrically or excentrically immersed in the gelatinous sheaths. Others, again, are free and unsheathed rodlets, some so short as to be mere cocci. ZEISS E, occ. 4.

Others, again, are free and unsheathed rodlets, some so short as to be mere cocci. ZEISS E, occ. 4.

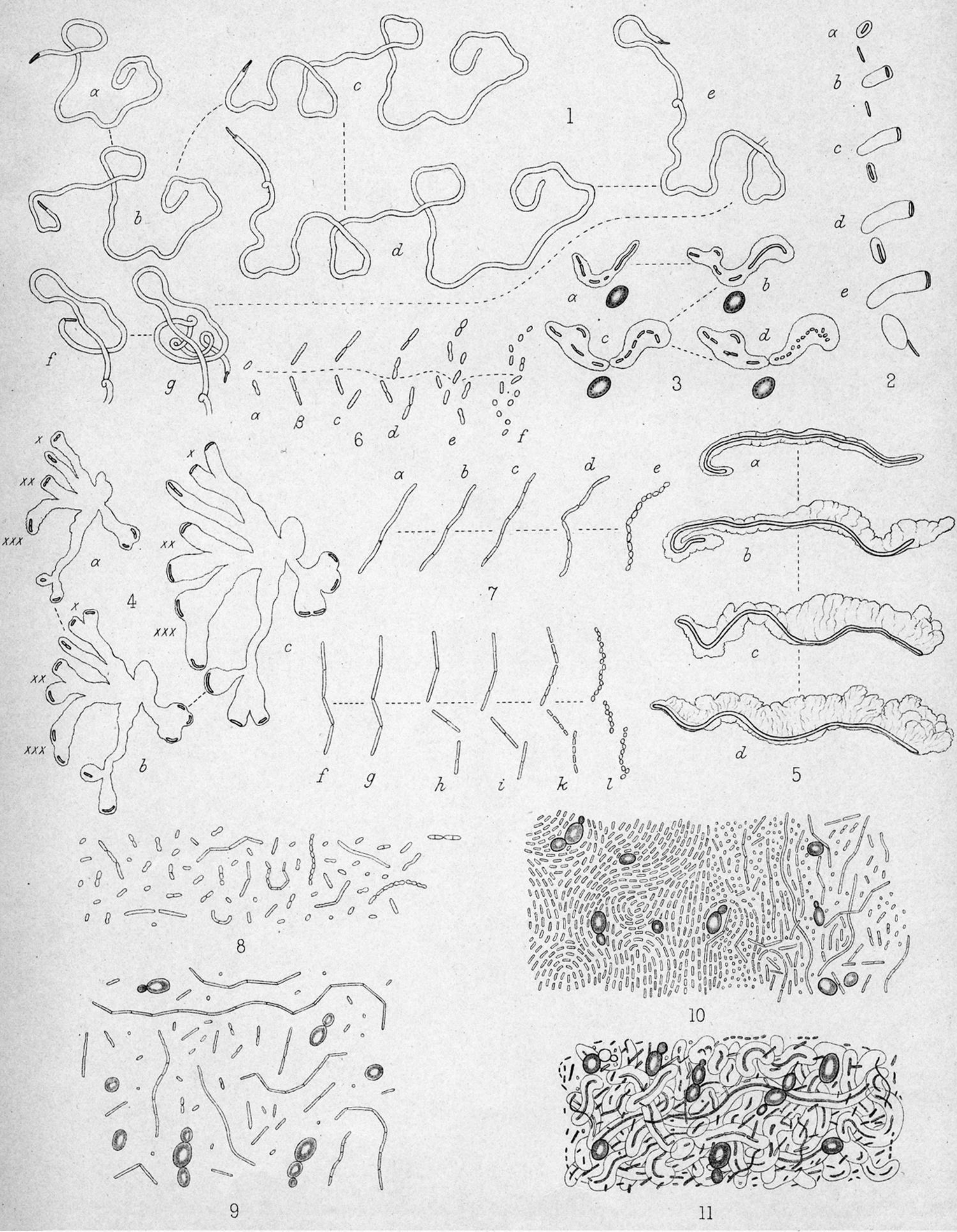

PLATE 14.

Fig. 1. Various stages in the development of the gelatinous sheathing substance by a rodlet observed in a hanging-drop of bouillon-Pasteur, stiffened with gelatine. The drop was infected with organisms from a marked tube, August 14, at 10 A.M.; on the 15th the development had begun. *a* = a coiled sheath with the rodlet at the left end, at 4 P.M. (August 15); *b* the condition of affairs at 9 P.M. same day—the rodlet has advanced considerably to the left, and begun to return across its path, the latter being indicated by the gelatinous substance found. *c* = 7 A.M., August 16; a new loop had been formed during the night, and the erratic rodlet is forming another, but does not complete it (*d* = 1 P.M., and *e* = 7 P.M., August 16). On August 17 another loop is formed (*f* = 9 A.M., August 17), and during the next twenty-four hours a series of coils and loops are completed (*g* = 9.30 A.M., August 18). No further changes occurred, though the specimen was watched till August 27. ZEISS, D, occ. 4.

Fig. 2. Stages in the behaviour of the small sheathed rodlets, observed in a hanging-drop of beet-gelatine, May, 1891 (from a marked tube). At 10 A.M. on May 29, temp. = 17° C., the two rodlets shown at *a* were fixed and drawn. At 12 noon of same date the sheathed one had changed its position, as shown at *b*, and had added to its sheath; the free rodlet remained unaltered (temp. = 20° C.). *c* shows the further growth of the sheath of the former at 4 P.M. of same date, and a slight sheath now invests the other rodlet, the temperature having again fallen to 17° C. Next morning, at 10 A.M. (temp. = 13° C.), the first one had added considerably to its sheath, and the free rodlet had now a very evident swollen sheath, the rodlet lying at one end (*d*); at 4 P.M., same date, the first sheath had grown yet larger, and the second rodlet had escaped bodily from its (also slightly more voluminous) sheath. Temp. = 13° C. No further changes could be observed. ZEISS, D, occ. 4.

Fig. 3. Changes observed in Pasteur-bouillon (equal volumes) stiffened with gelatine, and in an atmosphere of carbon dioxide. The preparation was made from a fourth day's culture of the Ginger-beer plant, in PASTEUR'S solution, in a soda-water flask (B). At 4.30 P.M. on September 1 the yeast-cell and a neighbouring row of rodlets, in sheath, were fixed (fig. 3, *a*). At 10 A.M., September 2, the rodlets were growing and dividing in the sheath (*b*). This went on, and on September 3, 9 A.M., the right-hand longer rodlet had begun to break up into bacteria (*c*), which had next day divided again into cocci. The yeast-cell remained quiescent throughout. ZEISS, D, occ. 4.

Fig. 4. Curious branching of the sheathing matrix by the repeated growth and division of the peripherally situated Schizomycete. From an eight days' fermentation in Pasteur-bouillon-gelatine, a culture was made in a drop of ginger-gelatine on September 9; several yeast-cells were present in the drop. The specimen *a* was fixed under the microscope at 10 A.M.; at 4 P.M. (*b*) the rodlets marked *x*, *xx*, and *xxx* had divided, separated, and advanced laterally to the left, adding to the gelatinous matrix as they did so, similarly with those on the right. *c* shows the condition of affairs next morning at 10 o'clock. No further changes were traced. ZEISS, D, occ. 4.

Fig. 5. Changes induced in a sheathed filament when transferred from one medium to another. The specimen was from a four days' fermentation in normal PASTEUR'S solution and ginger. On September 1 it was transferred to a drop of PASTEUR'S solution, to which Pasteur-bouillon-gelatine was added. Fig. *a* was sketched at 9.30 A.M. on September 2; *b*, at 2.30 P.M., same date, its sheath is swelling and peeling off, as it were. *c* = 9 A.M., September 3, the swelling has increased, and produced contortions of the filament, the growth of which is scarcely noticeable. *d* = 9.30 A.M., September 4, the swelling and wrinkling of the sheath have increased. Nothing occurred further except a slight increase of the swellings on the right hand, although the specimen was watched till September 7. ZEISS, E, occ. 4.

Fig. 6. Division of the motile bacterial form in a drop of bouillon-gelatine-sugar. *a* at 10 A.M.; *b* at 4 P.M.; *c* at 7 A.M. next day; *d* at 2 P.M.; and *e* at 5 P.M.; *f* on the third day. The division was very slow, apparently owing to the gelatine. The final result was the formation of cocci, which remained unchanged in the matrix. ZEISS, E, occ. 4.

Fig. 7. Two of the filamentous forms of *Bacterium vermiforme*, in a hanging-drop of bouillon-gelatine-sugar, and breaking up into segments, then shorter and shorter rodlets, and finally cocci. ZEISS, E, occ. 4.

Fig. 8. Typical group of the swarming filaments and rodlets, breaking up into cocci, from a culture in bouillon; drawn after staining with methyl-violet, as seen under SWIFT'S $\frac{1}{2}$ -in. apochromatic oil-immersion.

Fig. 9. Type of a fifteen days' synthetic culture of the *B. vermiforme* together with *Saccharomyces pyriformis*, in bouillon-glucose. The yeast is budding freely. The Schizomycete grows out into long filaments, which then break up into the swarming rods of various lengths. ZEISS, E, occ. 4.

Fig. 10. Type of a fifteen days' synthetic culture of the yeast and bacterium in bouillon only. The yeast buds slowly and for a short time only. The Schizomycete grows out into filaments, which rapidly break up into very short rodlets (bacteria) and cocci. ZEISS, E, occ. 4.

Fig. 11. Type of a fifteen days' synthetic culture of the yeast and bacterium together in a suitable saccharine medium (Pasteur-bouillon). The filaments and rodlets ensheath themselves as soon as the carbon dioxide is in excess, and entangle the well-developed yeast-cells in the coils of the gelatinous matrix. The mass becomes denser and denser, and at last forms the hard brain-like lumps of the Ginger-beer plant, so like those figured at Plate 13, fig. 1, that it was unnecessary to draw special figures of them. ZEISS, E, occ. 4.



Schizomycete No. 2.—Ginger-bacillus.

PLATE 15, figs. 1-6.

- Fig. 1. Two characteristic groups of the bacillus in the filamentous condition, as found on the surface of glucose solution forty hours after immersion of a piece of ginger. January 5, 1891. ZEISS, E/4. In B, many of the filaments run parallel, and show septa; in A, some are breaking up.
- Fig. 2. Bacillar rods obtained by twenty-four hours' culture of above filaments on gelatine. The filaments simply disjoint into rods, which then swarm. Some of the longer rods are still disjointing. ZEISS, E/4.
- Fig. 3. A mass of spores obtained from the above culture forty hours later than last phase. All the filaments and rods at the top of the liquefied gelatine have formed spores thus: below the surface they are still breaking up, as in fig. 1, A, and fig. 2. These spores are embedded in an indistinguishable matrix. ZEISS, E/4.
- Fig. 4. Two groups of spores and spore-forming segments, more highly magnified (ZEISS, L/4). A from the original culture in glucose, on the fifth day; B from the group shown in fig. 3 (under a lower power) and stained with iodine.
- Fig. 5. A. Group of the spores of figs. 3 and 4 sown in a hanging-drop of PETER'S gelatine at 4 P.M. on January 10, and placed in the incubator at 27° C. B. Bacilli developed from the spores at 9 P.M., January 11. C. Bacilli and filaments which are segmenting, at 10 P.M. next day. D. Spore-forming segments in same culture. All ZEISS, E/4.
- Fig. 6. Germination of the spores. α = a sowing of the ripe spores in gelatine-glucose made on March 30, and kept at 28°-30° C. On the 31st, at 10 A.M., they had swollen, and several of them were germinating (fig. 6, β) into bacillar rods. (SWIFT $\frac{1}{2}$ homogeneous oil immersion.)

Schizomycete No. 3.—Bacterium aceti (KÜTZ.).

PLATE 15, figs. 7-9.

- Fig. 7. Two groups of the normal *Bacterium aceti*, obtained from a strong "Vinegar-plant," grown on acidified claret and water. ZEISS, E, occ. 4.
- Fig. 8. Two groups of *Bacterium aceti* from the top of a tube-culture of the "Ginger-beer plant" with free access of atmospheric oxygen. ZEISS, J, imm., occ. 4.
- Fig. 9. A group of "involution forms" of *Bacterium aceti*, obtained from the film of an old culture of the Ginger-beer plant. ZEISS, J, occ. 4.

Oidium lactis (FRESEN.).

PLATE 15, figs. 12 and 13.

- Fig. 12. Characteristic group of the yeast-like form as found on the surface of flask 18. December 13, 1889. ZEISS, E/4.
- Fig. 13. Culture from a single cell isolated in a hanging-drop of peptone-gelatine. α , the cell at 10 A.M. on November 7th, 1889; β , 9 P.M. same day; γ , 9 A.M. next morning; δ , part of the mycelium twenty-four hours later; it is becoming disjointed into the yeast-like segments of fig. 1. ZEISS, D/4. (Temp. 14°-15° C. throughout.)

Dematium pullulans (DE BARY).

PLATE 15, fig. 14, and PLATE 16.

- Fig. 14. A, a characteristic group of the cells and mycelium as found on the boiled Ginger-beer plant, and placed in ginger-gelatine in a hanging-drop on February 14. The segment α was marked (2 P.M.) and watched; b , the above segment at 10 A.M. next day; c , the same at 10 A.M. on the 16th; $d-f$, and at x , similar series traced for other segments. (Temp. 14°-15° C.) ZEISS, D/2 and D/4.

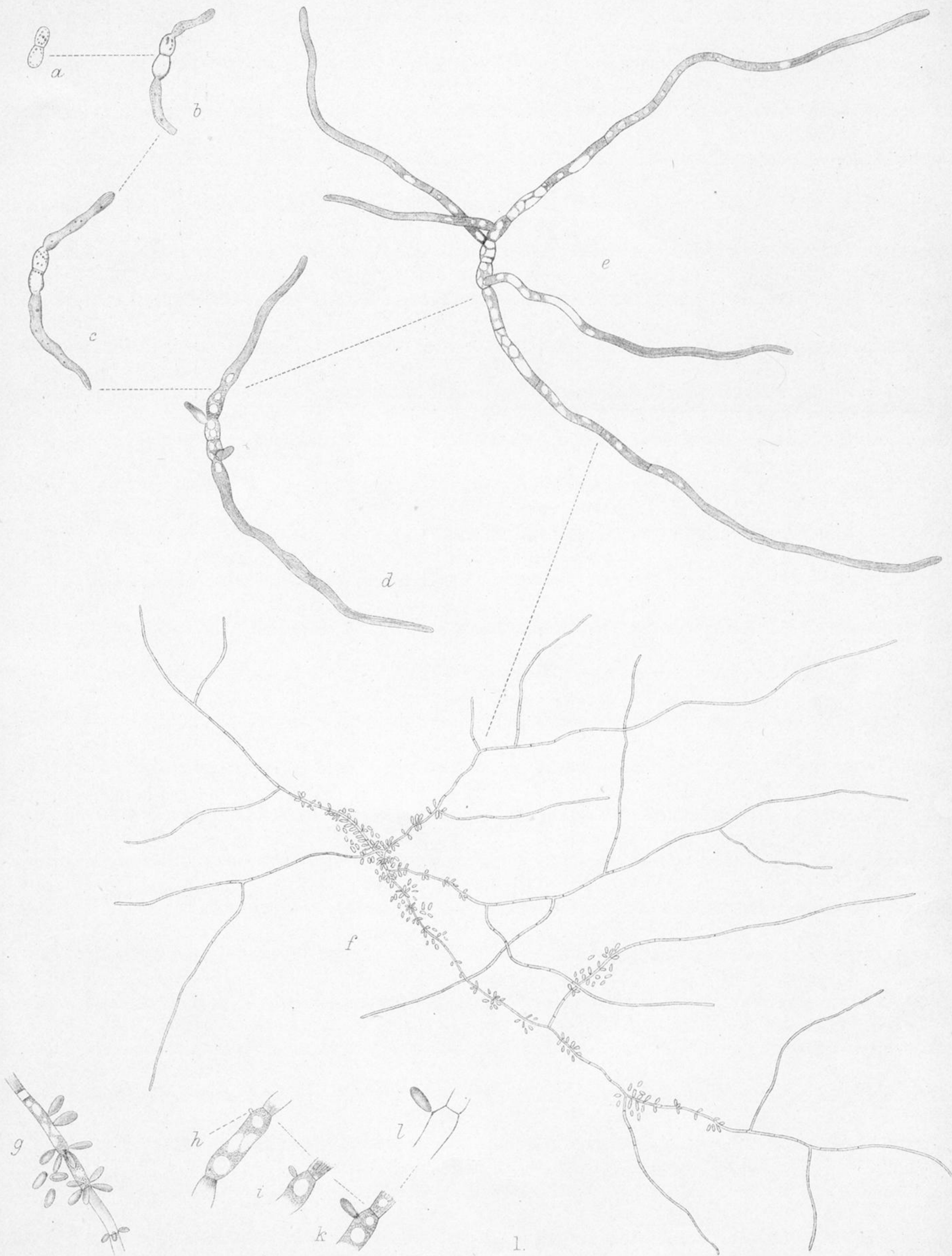

PLATE 16.

Fig. 1. Culture from a single segment, isolated in a hanging-drop of HAYDUCK'S glucose-gelatine, on February 14; *a*, at 4 P.M.; *b*, 10.30 A.M. on 15th (temp. = 17° C.); *c*, at 2 P.M. same day; *d*, at 8 P.M. same day; *e*, at 10 A.M. on February 16th. The brown colour pales somewhat, and the oil-drops gradually enlarge and run together as growth commences. The buds, when fully formed, fall into the drop and remain unaltered, unless transferred to fresh pabulum. All the above, ZEISS, D/4. *f*, the mycelium at 10.30 A.M. on February 17th, showing the copious development of buds now going on, and much less highly magnified (ZEISS, B/4). *g*, a small piece of a pullulating hypha, to the same scale as before (D/4): *h-l*, time drawings, showing the development of one of the buds; *h* at 10.50 A.M., *i*, at 11.30, *k* at 12.30, and *l*, at 1.15 P.M. ZEISS, J/4.